



Task 14 PV in the 100% Renewable Energy System

SPVPS

Active Power Management of Photovoltaic Systems – State of the Art and Technical Solutions 2024



What is IEA PVPS TCP?

The International Energy Agency (IEA), founded in 1974, is an autonomous body within the framework of the Organization for Economic Cooperation and Development (OECD). The Technology Collaboration Programme (TCP) was created with a belief that the future of energy security and sustainability starts with global collaboration. The programme is made up of 6.000 experts across government, academia, and industry dedicated to advancing common research and the application of specific energy technologies.

The IEA Photovoltaic Power Systems Programme (IEA PVPS) is one of the TCP's within the IEA and was established in 1993. The mission of the programme is to “enhance the international collaborative efforts which facilitate the role of photovoltaic solar energy as a cornerstone in the transition to sustainable energy systems.” In order to achieve this, the Programme's participants have undertaken a variety of joint research projects in PV power systems applications. The overall programme is headed by an Executive Committee, comprised of one delegate from each country or organisation member, which designates distinct 'Tasks,' that may be research projects or activity areas.

The 25 IEA PVPS participating countries are Australia, Austria, Belgium, Canada, China, Denmark, Finland, France, Germany, Israel, Italy, Japan, Korea, Malaysia, Morocco, the Netherlands, Norway, Portugal, South Africa, Spain, Sweden, Switzerland, Thailand, Turkey, and the United States of America. The European Commission, Solar Power Europe, the Smart Electric Power Alliance, the Solar Energy Industries Association, the Solar Energy Research Institute of Singapore and Enercity SA are also members.

Visit us at: www.iea-pvps.org

What is IEA PVPS Task 14?

The objective of Task 14 of the IEA Photovoltaic Power Systems Programme is to promote the use of grid-connected PV as an important source of energy in electric power systems. The active national experts from 15 institutions from around the world are collaborating with each other within Subtask B – Operation and planning of power systems with high penetration of Solar PV and Renewable Energy Sources (RES) – in order to share the technical and economical experiences, and challenges. These efforts aim to reduce barriers for achieving high penetration levels of PV Systems in Electricity Grids.

Authors

➤ **Main Content:** Ch. Bucher, S. Chen, G. Adinolfi, R. Guerrero-Lemus, Y. Ogasawara, G. Heilscher, I. McGill, M. Said El Hamaoui, C. Kondzialka, D. Mende, J. Wiemer, R. Bruendinger, A. Ghennioui, M. Said Elhamaoui, K. Ogimoto, E. Omine, Y. Ueda, J. Remund, A. Benazzouz, G. Graditi, T. Key.

➤ **Editor:** Ch. Bucher

DISCLAIMER

The IEA PVPS TCP is organised under the auspices of the International Energy Agency (IEA) but is functionally and legally autonomous. Views, findings and publications of the IEA PVPS TCP do not necessarily represent the views or policies of the IEA Secretariat or its individual member countries

COVER PICTURE

Tailem Bend Solar Power Farm, South Australia

ISBN 978-3-907281-46-8 Active Power Management of Photovoltaic Systems – State of the Art and Technical Solutions

INTERNATIONAL ENERGY AGENCY
PHOTOVOLTAIC POWER SYSTEMS PROGRAMME

Active Power Management of Photovoltaic Systems – State of the Art and Technical Solutions

**IEA PVPS
Task 14
PV in the 100 % Renewable Energy System**

Report IEA-PVPS T14-15:2024
January 2024

ISBN 978-3-907281-46-8



TABLE OF CONTENTS

Acknowledgements.....	7
List of abbreviations and Definitions.....	8
Executive summary.....	9
1 Introduction.....	11
1.1 Methodology and purpose of the report.....	11
1.2 Target audience	11
1.3 Why PV Curtailment is a Reasonable Grid Integration Measure.....	12
1.4 Value of Curtailed Energy	13
1.5 Alternatives to PV Power Curtailment.....	14
1.6 Curtailment at Point of Connection	14
1.7 Limitations of the Scope of this Report	15
2 Use Cases.....	16
2.1 Comply with Transmission Grid Constraints (Capacity Constraints)	16
2.2 Comply with Distribution Grid Constraints	16
2.3 Comply with Grid Connection Constraints	17
2.4 Collaborative Grid Optimisation.....	17
2.5 Provide Positive and Negative Control Power / Energy	18
2.6 Limit Overfrequency	18
2.7 Energy Market Participation	19
2.8 Flexibility Market Participation	19
2.9 Increase Capacity Factor	19
3 Active Power Management Landscape.....	21
3.1 Static Curtailment Methods	21
3.2 Dynamic Curtailment Methods	22
3.3 Communication Concepts and Requirements	29
3.4 Priority / Choice of Most Suitable Control Mode	30
4 Considerations on Curtailed Energy	31
4.1 General considerations	31
4.2 Example of Energy Curtailment Calculations.....	32



5	Standards and National Frameworks related to Curtailment	34
5.1	IEC.....	34
5.2	CENELEC	35
5.3	Austria.....	36
5.4	Germany	37
5.5	Japan	41
5.6	Morocco	48
5.7	Spain.....	49
5.8	Spain – Canary Islands	50
5.9	Switzerland	52
5.10	USA	52
6	Examples, Implementations, Projects	56
6.1	Austria.....	56
6.2	Germany	57
6.3	Japan	58
6.4	Switzerland	61
7	Recommendations.....	63
Appendix A: Special Situation of Japan.....		64
	Rapid renewable energy deployment.....	64
8	References	67



ACKNOWLEDGEMENTS

This paper received valuable contributions from several IEA-PVPS Task 14 members and other international experts. Many thanks to:



Schweizerische Eidgenossenschaft
Confédération suisse
Confederazione Svizzera
Confederaziun svizra

Swiss Federal Office of Energy SFOE

The Bern University of Applied Sciences is supported by the Swiss Federal Office of Energy (OFEN)



Bundesministerium
für Bildung
und Forschung



Bundesministerium
für Wirtschaft
und Klimaschutz

The Fraunhofer IEE and the Technische Hochschule Ulm contribution are supported by the German Federal Ministry for Economic Affairs and Climate Action and the “Projekträger Jülich GmbH (PTJ)” within the framework of the project “PVin100RESPTS” (FKZ: 03EE1009A/B). The authors are solely responsible for the content of this publication.



Funded by
the European Union



MINISTERO DELL'AMBIENTE
E DELLA SICUREZZA ENERGETICA

The Italian national agency for new technologies, energy and sustainable economic development (ENEA) is supported by the Italian Ministry of Environment and Energy Security in the framework of the Operating Agreement with ENEA for Research on the Electric System.



Federal Ministry
Republic of Austria
Climate Action, Environment,
Energy, Mobility,
Innovation and Technology

The Austrian contribution is supported by the Federal Ministry for Climate Action, Environment, Energy, Mobility, Innovation and Technology, by the FFG and by the IEA Forschungskoooperation.





LIST OF ABBREVIATIONS AND DEFINITIONS

The following abbreviations and definitions are used in this report:

Ancillary service	In this report, ancillary services normally refer to control power (primary, secondary, tertiary control) and voltage control (reactive power control)
APC	Active Power Curtailment
APM	Active Power Management
CF	Capacity Factor = annual energy yield / (nominal AC power * 8760 hours)
CLS	Controllable Local System
DER	Distributed Energy Resource
DSO	Distribution System Operator
FIT	Feed-in-Tariff
GWA	Smart Meter Gateway Administration
HEMS	Home Energy Management System
IEA	International Energy Agency
IED	Intelligent Electronic Device
KOF	Coordination Function
LCOE	Levelised Cost of Electricity
MG	Microgrid
MPP	Maximum Power Point
PV	Photovoltaics
PV penetration	PV energy produced in a given area divided by electrical energy consumed in the same area during one year
PCE	Power Conversion Equipment (also called inverter or converter)
PKI	Public Key Infrastructure
POC	Point of Connection, where the electrical installation of a building is connected to the public network
RPC	Reactive Power Control
RE	Renewable Energies
SMGW	Smart Meter Gateway
SMI	Smart Meter Infrastructure
SR	Sizing Ratio = P_{AC} / P_{DC}
TSO	Transmission System Operator



EXECUTIVE SUMMARY

In several countries, PV capacity has exceeded the country's minimum load. Unlimited feed-in at all times is therefore becoming less and less possible.

Active power management of photovoltaic systems, in some contexts also called curtailment, is a powerful grid integration measure. The energy loss due to curtailment is typically little compared to the increase of the PV hosting capacity.

Curtailment is not a goal. It is a method for increasing the utilization of power grids without exceeding their physical limits. The ratio of annual energy yield to peak power is smaller for PV systems than for many other power plants. This is why PV plants would need large grid capacities in relation to the energy yield. However, there is only little energy in the power peaks. Therefore, it is not economical to expand the electricity grids to the rated power of the PV plants.

Curtailment can be implemented in various ways, with today's PV systems accommodating many of these methods. The choice of method should align with the specific application for optimal results.

Once it is decided not to feed the power peaks into the grid, many new possibilities open up. The surplus electricity can be stored or used for less efficient applications. The feed-in can be ramped up and down highly dynamically. This makes system services for stabilising the electricity grid possible. A large number of such possibilities are outlined in this report.

If all these possibilities are exhausted, the PV system can also be curtailed so that the infrastructure is not overloaded.

The value of electric energy is typically zero or can become even negative when it is not needed. Curtailed energy usually has a low market value.

In the context of the energy transition efforts, it does not seem to make sense to curtail PV plants. However, with the costs that can be saved by avoiding grid expansion, much more solar power can be generated and fed into the grid without bottlenecks.

The remaining solar power becomes more valuable. Thus, the feed-in power of a curtailed PV system can both be increased or further reduced at any time and in a highly dynamic manner. For the first time, photovoltaic systems can assume full system responsibility and thus gain additional relevance and create new market opportunities.



Communication systems are becoming increasingly relevant. At the same time, their value increases with higher levels of PV.

While distribution grids used to be planned according to the "fit and forget" principle and PV systems were connected to the grid in an uncontrolled manner, PV systems with active power management may be actively controlled, based on the system conditions.

Autonomous controls such as static feed-in limitation, dynamic voltage limitation or even frequency control can be implemented decentrally without communication. However, if PV systems are integrated into the overall system and operated to optimise the distribution and transmission grid, communication systems are necessary. With increasing system responsibility of PV plants, the relevance of these systems increases.



1 INTRODUCTION

To reach the goal of a sustainable energy supply, large quantities of photovoltaic (PV) systems must be connected to the electrical energy grid. In many cases, the nominal DC power of the PV systems installed within a certain power system will surpass the PV hosting capacity by far. Depending on the situation, different grid integration measures can be taken.

One of the cheapest and most effective measures is to limit or reduce the AC power injected into the grid. For financial and system efficiency reasons, limiting the AC power of a PV system has been an optimisation task already at the beginning of grid connection of PV systems. Today, it is vastly accepted that it is not cost efficient to size the grid infrastructure to host PV peak production. In future, it can be expected that most PV systems will run in curtailed mode during several weeks of the year.

Curtailment is not a goal. It is a method for increasing the utilization of power grids without exceeding their physical limits.

PV systems running in curtailed mode potentially could offer new services. They could, while being operated in curtailed mode, e.g. provide symmetrical power flexibilities, active power set point operation or energy reserves and therefore additionally contribute to grid stability. Depending on control systems applied, they could be used to reduce forecast errors or to compensate for unexpected load or production changes. This curtailed mode for PV could be even more valuable in insular power systems, where the grid frequency is typically less stable than in large interconnected continental grids.

1.1 Methodology and purpose of the report

In this report, different methods of PV power curtailment and their application in electric installations and power grids are presented and discussed. Different solutions used in different countries will be shown and applicable standards will be presented.

This report presents methods for active power management (APM) of PV systems. This report is not primarily concerned with the question of whether APM is necessary. However, if APM has to be introduced, this report provides assistance for optimal implementation.

This report also points out possible alternative measures to PV power curtailment such as the application of decentralized energy storage systems, self-consumption behind the meter or grid reinforcement. However, these measures are out of scope of the report and will only be mentioned briefly.

1.2 Target audience

The information and findings provided in the report are targeted to technical experts from the utility sector, project developers as well as technical consultants, seeking for technical solutions and experiences on the implementation of active power management.



In addition, the contents of the document are also highly relevant for the work of standardization and professional organizations and regulatory authorities.

1.3 Why PV Curtailment is a Reasonable Grid Integration Measure

Of all electrical power sources, PV systems have the lowest capacity factor (equals lowest annual nominal hours of operation or the highest peak power to energy ratio). Limiting power peaks will therefore reduce stress on the power grid more than for all other power generating technologies. Figure 1 shows the one minute irradiance on a horizontal plane in Switzerland, central Europe. On this figure it is indicated how much of the irradiation (annual energy) would be lost if only the irradiance below a certain level was harvested.

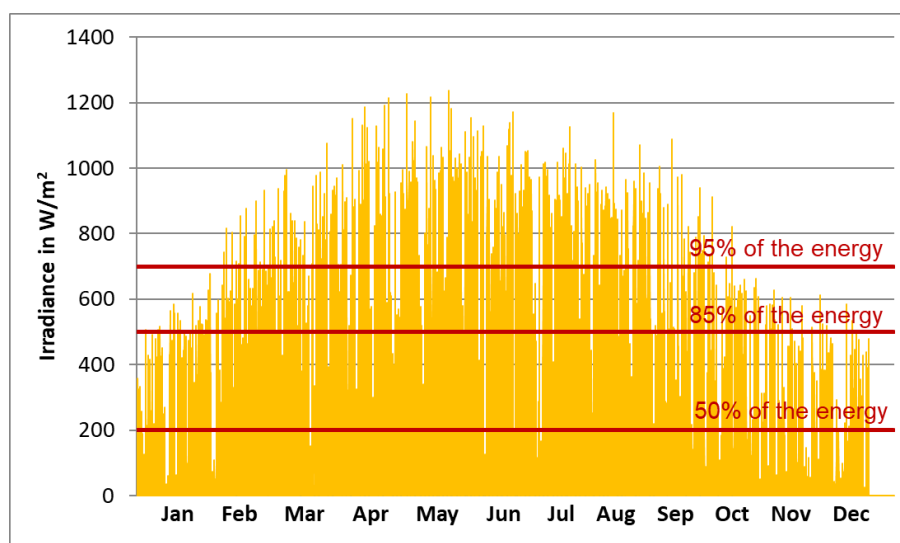

Figure 1: Curtailing PV power has only a limited influence on PV energy production (Data: Meeonorm for location Bern, global horizontal irradiance) [1]

The Firm Power Generation study developed by the IEA-PVPS Task 16 [2] estimated the economic optimum of curtailment: Oversizing the PV park and accepting a certain energy loss by curtailment is cheaper than installing less PV but adding seasonal storage to the system. Figure 2 shows, that this optimum is around 60% system oversizing and thereby losing roughly 15% of PV energy yield due to curtailment.

This shows, that a certain amount of curtailment can be cheaper than any other grid integration measure. Also a study of SERIS [3] has shown that curtailment is among the cheapest options for grid integration, especially if it is combined with other measures. When assuming that electricity prices are generally low or may become even negative during times when curtailment is needed, the business case would be even better.

However, curtailment should only be the last option if the PV energy cannot be used elsewhere. Many options of how to deal with feed-in power limitations are presented in this report, see also Chapter 1.5.

From an ecological perspective, too, it can be worthwhile to build more photovoltaics and less grid infrastructure thanks to the low ecological footprint of PV modules. Corresponding criteria should be taken into account in an overall strategy.

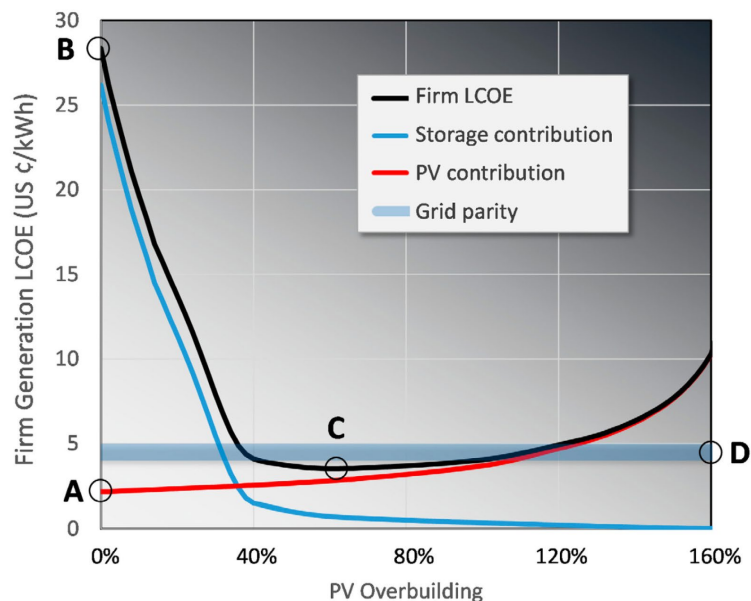

Figure 2: “Firm Generation”: Adding more than 100% PV on an annual energy basis reduces need for storage and saving costs [2]. LCOE = Levelised Cost of Electricity.

1.4 Value of Curtailed Energy

In times of PV penetrations far below today’s renewable energy targets of many countries, the standard measure to avoid curtailment is grid extension in order to enable power transfer to where it is needed. This maxim was true in many systems for many years to build a solid backbone for energy transport. However, this is normally expensive and time consuming. In systems with high PV penetrations grid extension is no solution against curtailment if there is no consumer within the respective grid who consumes the energy at that point in time. For example, if several European countries export electrical power at a given time, other European countries must import the same amount of electricity at the same time.

The value of electric energy is typically zero or can become even negative when it is not needed. Therefore, curtailed energy has typically only little value.

PV systems often need to be curtailed when there is an abundance of excess energy. If grid restrictions were not in place, the electricity market price in such situations would likely be extremely low, or even negative, given today’s market conditions. From an economic standpoint, the energy that is curtailed is considered to be of low value.

On the other hand, new business cases how to consume free energy might arise if frequent, planned curtailing is expected. All time-independent or time variant processes (e.g. due to thermal storage capacities in private, public or industrial environments) could benefit from actively using normally curtailed and therefore not used PV energy. Apart from that, also energy consuming transformation processes (such as all scale of P2X) could become a business case when regarding



the low value, or even negative prices, in times of excess energy. The prerequisite is that the infrastructure for utilising this energy can be made available.

1.5 Alternatives to PV Power Curtailment

Curtailment should not be the primary mean to integrate more PV to the grid. There are several methods or solutions which can be complimentary to the curtailment of PV systems. Such methods or solutions are:

- Reactive power control or tap changing transformers to mitigate voltage constraints.
- Curtailment of non-renewable power generators in the same power grid (e.g. gas fired power plants)
- Flexible loads, demand response and demand side management
- Management of PV production in microgrids systems to locally supply loads (cooling, lighting, etc) and storage charging operations. Adequate microgrids controllers can limit/avoid PV energy injection in the main grid. Additional advantages can be obtained if PV generators are integrated in Direct Current (DC) microgrids (absence of reactive power and a restrained number of AC/DC conversions).
- Storage systems, both small scale (normally batteries) or large scale. A special focus could be on low cost and low efficiency storage systems.
- Transmission or distribution grid reinforcements (however, distribution grid reinforcement is typically a local solution which doesn't mitigate curtailment if the PV penetration homogeneously rises within a whole grid area).
- Finding a good balance between different variable renewable energy resources which correlate negatively (typically wind and solar).
- Geographically distribute PV systems and use various orientations or tracking systems to compensate for local power peaks due to local weather patterns.

*Curtailment is only the last option.
But it is also the most powerful one.*

However, none of these methods or solutions can guarantee unlimited hosting capacity for PV. Therefore, PV curtailment (in its different realisations) should always be considered as an ultimate backup solution when high PV penetration scenarios are expected.

1.6 Curtailment at Point of Connection

The easiest way to curtail PV power is by commanding the PV inverter to limit its power output to a given value. This approach still applies to feed-in only PV systems like most solar parks and several older roof top systems. In other systems the self consumption of the generated PV power is a significant foundation of the business model by the operator. This also applies to hybrid solar and battery power plants whose number will increase due to the availability of affordable battery systems. Curtailment should respect the borders of ownership therefore and be applied to the POC.



*If curtailment is required, it should be required at the point of connection,
not at the inverter of the PV system.*

Requiring power limiting at the POC allows the PV system owner (often a prosumer) to propose new innovations such as different types of energy management systems. Even electrical load dumping in a geothermal loop of a heat pump (which is usually not efficient as much of the energy is dissipated through the ground) is more efficient than a sole curtailment of the PV system.

1.7 Limitations of the Scope of this Report

Although this report is called “active power management”, it focuses only on PV power curtailment methods. Other methods for better grid integration are partially tackled, but not discussed in detail.

Also, financial and market implications are not investigated in this report. To curtail PV systems is financially beneficial for a society. However, the cost savings are in the domain of grid infrastructure, whereas the costs for the curtailed energy are primarily borne by PV system owners. In order to make curtailment an accepted grid integration method, this process must be understood, and PV system owners must have sufficient benefits to implement curtailment.



2 USE CASES

Active Power Management (APM) and therefore PV power curtailment is required in many situations. Typical reasons for PV curtailment are:

- **Power constraints within the local electrical system** (e.g. the electric installation in a building and the connection to the network): From a financial but also environmental point of view it doesn't make sense to size the AC part of a PV system (thus the power conversion equipment (PCE) and its connection to the mains) according to the highest possible DC power which could be generated in the PV array.
- **Power or voltage constraints within the distribution system**: Likewise, it's neither realistic nor desirable to size a distribution grid for the peak PV capacity in a high PV penetration scenario. Whenever high production meets low demand, PV curtailment is one possible option to maintain system stability.
- **Need for ancillary services**: Independent of its size, an electrical system requires certain ancillary services. Flexibility in power production or consumption is one of the most important ancillary service. As modern PCE, such as PV converters, are fast and easy to control, they are suitable for such ancillary services. However, to provide both positive and negative control reserves, PV systems must run in curtailed mode.

In the following sections, the use cases are discussed in detail.

2.1 Comply with Transmission Grid Constraints (Capacity Constraints)

Already today, wind and solar production exceeds demand plus export capacity in certain regions of the world [4]. Coordinated curtailment (congestion management) is thereby the only quick solution to ensure power balance and thereby grid stability. If too much of the energy is curtailed, it is recommended to implement other solutions, see Chapter 1.5.

Nowadays, grid bottlenecks caused by large, centralised PV power plants are often countered with grid expansion. Although this is a sustainably helpful measure, it only solves the problems initially. As soon as the production surplus is system-wide, grid reinforcement does not bring any added value. Then, power management or strategically placed storage must be introduced. In any case, even then, PV system curtailment is an important "pressure relief valve" for the power grid.

2.2 Comply with Distribution Grid Constraints

2.2.1 Voltage constraints

Voltage constraints, typically over-voltage, can often be observed in rural grids with high PV penetration. Curtailment of PV systems can be done using for example decentralised volt-watt control functions. Such curtailment solutions ensure the grid voltage to remain below a defined limit, if voltage rise is caused by respective PV systems. However, without additional measures such as impedance-depending voltage bands, it's always the systems which are located at the end of the line which are curtailed the most. From a technical point of view, this is a desired side-effect, as the highest hosting capacity can be achieved. However, (financial) compensation should be foreseen in this case to treat all systems equally.



In some locations, such as the very high penetration in South Australia or in an island case, volt-watt may be used as a contingency measure. By raising voltage at the substation, a graduated volt-watt function can be hastened. There is typically not compensation for contingency although the outcome has the societal benefit of maintaining grid reliability.

A novel approach of decentralized volt-watt control with financial compensation of prosumers by the DSO has been proposed by the Swiss DSO Groupe E [5].

2.2.2 Capacity constraints

Unlike voltage constraints, capacity constraints in distribution grids such as thermal loading of cables or transformers cannot be detected at the decentralised PV system level. Therefore, central control systems must be implemented to mitigate these constraints. When doing so, curtailment is a cheap and most effective method to integrate big numbers of PV systems in a distribution grid.

2.3 Comply with Grid Connection Constraints

Grid connection constraints should not be confused with grid constraints: Grid connections are typically characterized by the fact that they only affect one customer (for example one house), and that in certain countries such as Switzerland, Spain or Japan the landlords must pay at least a part of the connection reinforcement costs. Due to the direct financial benefit of the system owner, PV system curtailment is often used if the full rooftop capacity shall be used for PV but the grid connection cable doesn't allow to feed in all the power. For this use case, several curtailment-methods can be appropriate (see also Chapter 3):

1. Inverter sizing (generator over-sizing)
2. Software limitation of PV production (typically done if grid connection reinforcement is announced but not done yet)
3. Local self-consumption optimisation including grid injection control

The third option can generally be seen as the most relevant option, as least energy is lost.

Some DSO claim, self consumption wouldn't reduce the required grid capacity for a PV system, as it is not always available. If nobody is at home during a sunny summer weekend, storage systems are fully charged, no electrical vehicle is connected to the wall box and all hot water storages are heated up, only curtailment ensures to keep a defined power injection limit below the inverter capacity. This has been the case in South Australia.

In countries where prosumers do not have a legal right to connect any system size to the grid without paying for possible grid reinforcement costs, this use case is already wide-spread. See the Japanese example in the 2021 IEA PVPS Task 1 report. The service for self-consumption becomes more popular in Japan including PPA (Power Purchase Agreement) models [6].

2.4 Collaborative Grid Optimisation

Another possible solution could consist in adopting a collaborative planning mode among TSO (responsible of Unit Commitment and dispatch operations) and PV plant owner. It is based on the idea that native DC generation (PV, H₂, etc), loads and storage can be effectively managed in DC distribution.

This solution is characterized by different advantages in terms of reactive power absence and restrained number of AC/DC converters. The DC microgrid including PV plant, DC load and storage is connected to the main AC grid by a bidirectional DC/AC converter.



The microgrid controller forecasts its RES generation and demand timeseries. Then it provides such information to the TSO communicating its needs, resource for the successive day and its availability to support the main grid for active power provision.

On the base of different available generators and load requirement, the TSO executes the Unit Commitment process to identify synchronous and renewable generation mix. In case of not enough synchronous generation assuring grid balance, TSO quantifies the necessary production surplus or lack, and it plans DC resources involvement. In the proposed approach this is defined as the “Collaborative Planning Mode” since the TSO asks for the microgrid support. The microgrid controller receives the TSO requests in terms of desired injection/absorption profiles and runs an optimisation algorithm to suitably schedule internal resources.

In case of DC microgrid unavailability to support the main grid for active power provision, its controller optimizes internal resources and manages internal loads to maximize self-consumption, also minimizing energy sinking operations from the main grid.

Because direct communication from TSOs to a microgrid would probably not be proportionate, it can be assumed that other stakeholders such as aggregators could be used for this case.

2.5 Provide Positive and Negative Control Power / Energy

Utility scale PV power systems are typically equipped with PV plant controllers. Depending on the demand of the system operator, they can offer various ancillary services. For economical reasons, the nominal module capacity would typically be larger than the rated inverter capacity. Also, transformer stations, switch gear and grid connection are not dimensioned for nominal PV module power, but for the nominal inverter power. Some of the equipment can be overloaded during some time and must only respect power constraints in average (e.g. most transformers). In this case, a PV system can provide symmetrical primary control power and follow e.g. an external signal or a frequency droop function. In average, the energy production is not affected by this use case (see also Chapter 5.5, Japanese Case]).

*PV systems cannot provide time-based ancillary services.
Ancillary service markets must be reformed in order to integrate PV systems.*

If systems are curtailed based on a signal of the system operator and not based on their own power rating limitation, the provision of symmetrical control power is normally not subject to any additional costs. However, as most control power markets do not accept control bids which are based on instantaneous power production but rather on hourly schedules, the integration of PV systems into the ancillary service market is not advanced yet [7].

2.6 Limit Overfrequency

To limit overfrequency in an adequate way has been a primary concern of system operators ever since PV systems account for a relevant power share in a synchronous power grid. In the early 2010s, a droop control function was introduced in Europe to limit the power production of PV systems when they surpass 50.2 Hz. However, this function is only used as an emergency function to be activated in situations which occur only rarely.



Whenever PV systems are operated in curtailed mode, they could theoretically provide symmetrical primary frequency control power and thereby be classified as so called “must run capacity.” In some cases obsolete gas fired power plants situated in a critical location may be “reliability-must run”. However, in order to introduce such a concept, the current balancing energy markets would have to be adapted.

2.7 Energy Market Participation

Aggregators typically switch off PV systems if they see negative market prices. Residential systems which are not operated by aggregators are normally not exposed to variable prices and will therefore never be switched off due to market constraints.

2.8 Flexibility Market Participation

When participating to a flexibility market, dynamic curtailment might be necessary. Often this is done by an aggregator who controls a fleet of PV systems. As many large systems are equipped with battery systems too, curtailment is only applied when the battery storages are fully charged.

2.9 Increase Capacity Factor

PV systems typically have lower capacity factors (CF) compared to other power generation technologies, such as nuclear power stations and wind farms. The CF of PV systems is dependent not only on their place of installation but also on their spatial distribution, as well as the tilt and azimuth angle of the panels. Typical CF are (see also Figure 3):

- Central Europe (1000 full load hours): $CF = 1000 \text{ h} / 8760 \text{ h} = 11.4 \%$
- Southern Europe (1500 full load hours): $CF = 1500 \text{ h} / 8760 \text{ h} = 17.1 \%$
- Sunniest region in South America (>2000 full load hours): $CF > 2000 \text{ h} / 8760 \text{ h} = 22.8\%$

Low capacity factors lead to increased infrastructure needs, especially high transmission line capacity needs.

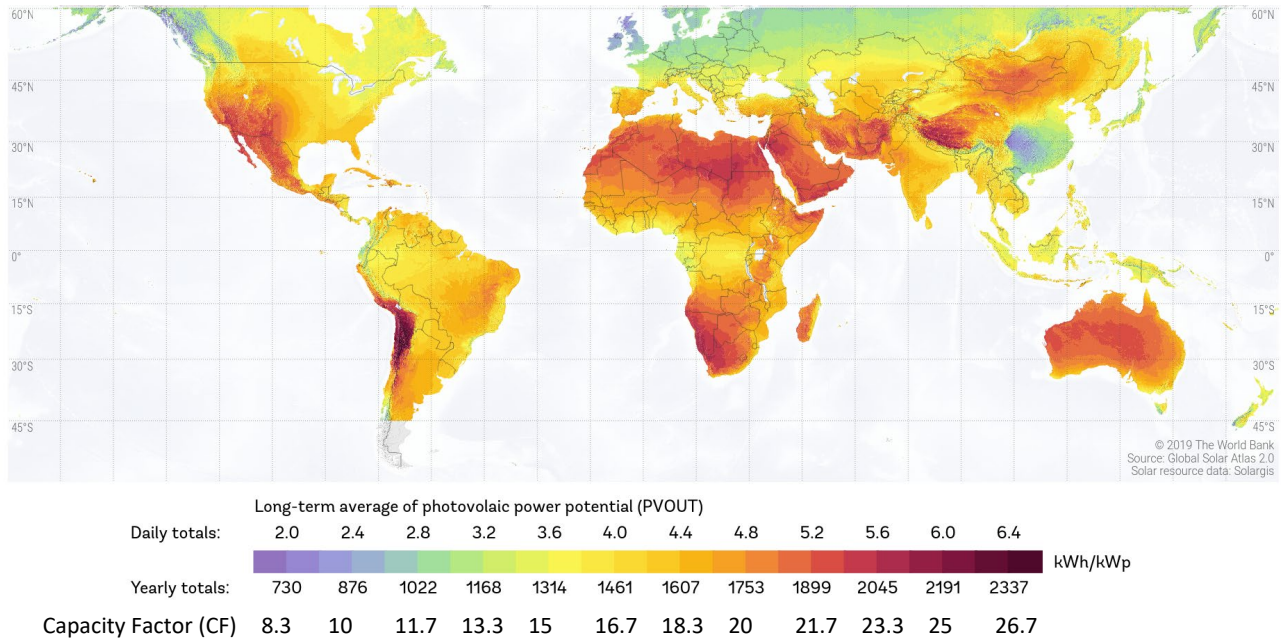

Figure 3: Photovoltaic Power Potential, modified with capacity factor of non-curtailed PV systems [8]. Modified legend: capacity factor is added [9]

By means of curtailment, the CF can be increased significantly. If a PV system in central Europe is installed with a Sizing Ratio (SR) of 50%, the Energy yield will be reduced by 5 to 10%, thus the CF can almost be doubled from 11.4% to roughly 20%.

Introducing storage systems can result in even higher CF for PV systems. This is particularly true in regions near the equator where seasonal fluctuations in solar irradiance are minimal, allowing for high CF to be achieved with just daily storage capacity. For instance, in the context of the “Sun Cable Australia Asia” (Power link between Australia and Singapore¹), discussions have centred around achieving CF rates of 75%. However, the amount of battery capacity required to achieve such a high CF is high, and the likelihood of the project coming to fruition is unknown to the authors of this report ([10], [11])

¹ 17-20 GWp solar farm, 36-42 GWh battery, and over 5,000 km of over-head and subsea transmission lines [10].



3 ACTIVE POWER MANAGEMENT LANDSCAPE

To curtail a PV system means to limit its AC output power. This can be done in many ways. Depending on the specific use case (see Chapter 2), different active power management methods can be implemented. While mitigating voltage constraints is typically done using volt-watt control functions, the thermal loading of grid assets normally requires a control signal to be sent to the PV system to initiate curtailment or enable export.

In this chapter, both static and dynamic curtailment methods are described. The relevance of the various curtailment methods is given, and considerations on the combination or prioritisation of the curtailment methods will be made.

Figure 4 illustrates range of active power management methods.

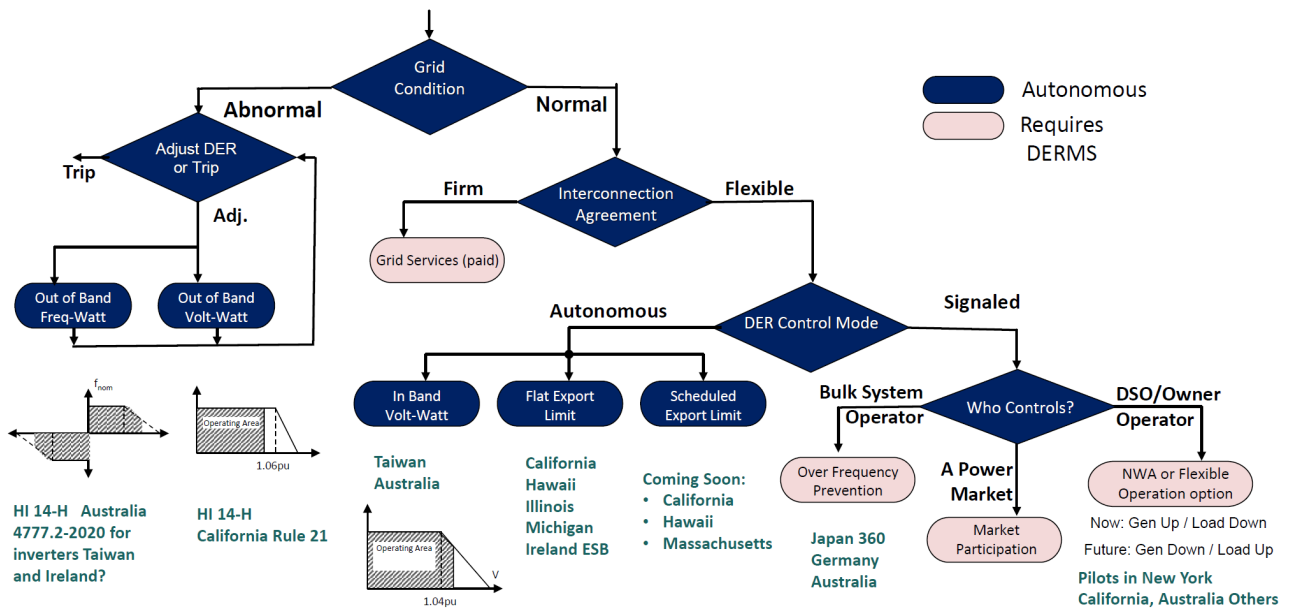

Figure 4: Overview of the different power management methods [12]

3.1 Static Curtailment Methods

Static curtailment methods refer to permanent power limitations set at the PCE level which can normally not be changed remotely. Depending on the PCE, manual updates of the curtailment limits at the PCE can be possible.

3.1.1 PCE Sizing

In reality, almost every PV system is curtailed using a sizing ratio SR (nominal AC power of the PCE divided by nominal DC power of the modules, $SR = P_{AC}/P_{DC}$) which does not allow to convert the highest expected power peaks from DC to AC. Historically, the SR has been selected smaller than one to increase the average efficiency of PCE's. Today, the SR is normally chosen smaller than one due to financial system optimisation. The limited energy contribution of power peaks does normally not justify higher costs on the AC side of the system.



PCE manufacturers normally don't allow unlimited over-sizing of the generator. Data sheets or planning tools of PCE manufacturers indicate minimum sizing ratios. However, discussions with PCE manufacturers show that the limitation of PCE sizing regarding life expectancy of the inverter is not well understood yet. A study by the Bern University of Applied Sciences [13] does not show a clear correlation between PCE sizing and life expectancy of PCE's.

3.1.2 Constant PCE Power Limitation

The maximum output power of PCE can be limited by changing the PCE settings. This function is normally not used, because using smaller PCE would lead to the same result and save costs. However, in some cases, constant PCE power limitation is applied:

1. The maximum power of the PCE is critical for the AC installation, but no PCE of the required size is available. In this case, a more powerful PCE can be installed and its maximum AC power output can be constantly curtailed.
2. A given POC does not allow the connection of a large PV system, but grid reinforcement is planned. It might be beneficial to install a large PV system which can only partially feed into the grid as long as the reinforcement isn't completed. Once the POC has been reinforced, the PCE limitation can be removed.
3. In case of unexpected current or voltage violations of an existing distribution system, a power limitation at the PCE can be a quick and cheap temporary or permanent solution to mitigate the negative impact of the PV system to the grid.

Unlike for the PCE sizing, there is normally no lower limit for constant PCE power limitation.

3.2 Dynamic Curtailment Methods

Dynamic curtailment methods require permanent signal processing and control actions at the PCE level. The control action can both be closed loop or open loop. While closed loop is often used for local control signals, remote control signals such as DSO ripple control signals are often based on open loop control only (from a PV system's perspective).

The following sections describe various dynamic curtailment methods. Possible combinations and hierarchies are described in Chapter 3.4 Priority / Choice of Most Suitable Control Mode.

3.2.1 Local Dynamic Power Curtailment

Local dynamic power curtailment is normally used to limit the power injection from a prosumer to the grid while optimising the self consumption. A simple scheme for local dynamic power curtailment is shown in Figure 5. Today, most PCE for residential use offer some sort of local dynamic power curtailment functionality. A major challenge is the combination of several devices of several manufacturers within the control loop. Investigations show, that these control systems are not robust against failures such as interruption of the control signal [14].

For utility scale PV power systems, local dynamic power curtailment is normally done by means of plant controllers. In contrast to small residential systems, plant controller based control systems are commissioned with extensive functional tests. They are generally robust and fail safe. Plant controllers normally offer several control functions. Curtailment of PV power is just one of them.

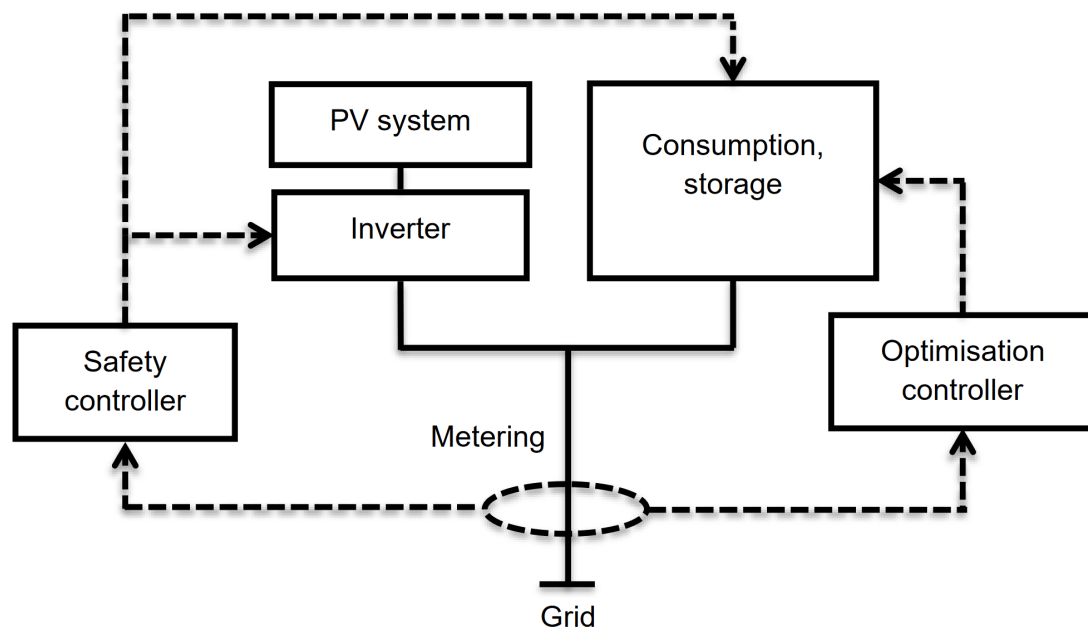

Figure 5: Example of a local dynamic power curtailment system [1]

3.2.2 Frequency Droop Control

Frequency droop control or primary control is used to stabilize power grids. If the grid frequency is above the nominal frequency, generators reduce their power output. Frequencies below the nominal frequency result in higher generator output (Figure 6).

According to most grid codes, PV systems must follow such a droop control function if the frequency reaches values above a certain level. In the European power grid, this level is 50.2 Hz [15].

For PV systems, this method is typically used for distorted grid operation only. Because curtailment always leads to a loss of energy, PV systems are normally not part of the frequency control in normal operation. However, when PV systems are operated in curtailed mode anyway, symmetrical frequency droop control would be easy to implement. Thereby, PV systems could replace conventional must-run generation units which are often operated in parallel to PV systems, even if this was not needed from an energetic point of view.

Another typical application of frequency droop control is used in AC coupled off-grid systems. A central master PCE sets and rises the frequency if too much power and/or energy is fed into the system. PV PCE which are compatible to the corresponding operation mode will lower their output power if the frequency rises. The German inverter manufacturer SMA has proposed these solutions already many years ago for their off-grid systems Sunny Island [16].

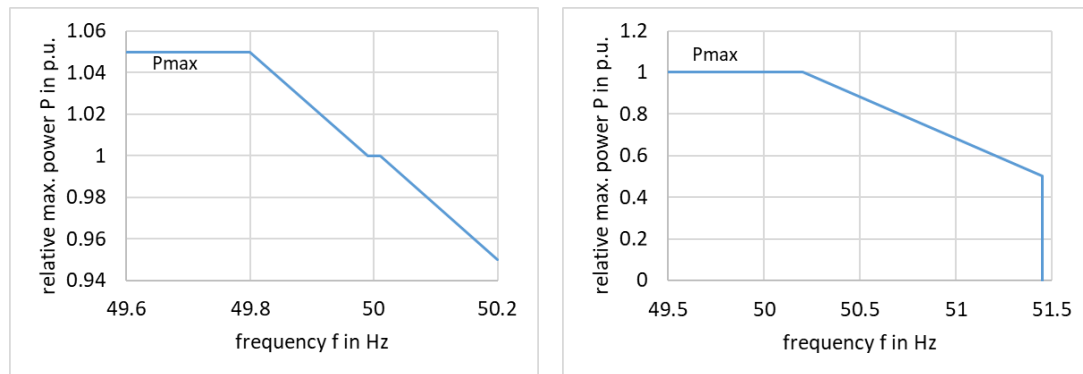

Figure 6: Example of a symmetrical $P(f)$ droop function for normal operation (left) and a standard asymmetrical over-frequency power reduction function (right)

Trivia: PV PCE have always provided a sort of $P(f)$ functionality. When the frequency rose over 50.2 Hz they had to switch off. This control behaviour was good enough for a few inverters connected to a strong power grid, but it turned into a risk for high PV penetration scenarios, as it can cause blackouts and does not support grid stability.

3.2.3 Voltage Droop Control (Volt-Watt Control)

Distributed PV systems can cause the voltage to raise above the acceptable values. This can be a limiting factor for the PV hosting capacity especially in weak rural distribution grids. In many cases, this occurs rarely and doesn't justify expensive measures such as grid reinforcement, installation of decentralised storage systems or online tap changing transformers.

To reduce the power of the PCE in case the voltage reaches or exceeds a certain limit can be one of the most economic and most effective measures, as long as the energy losses are low. A major drawback is the fact that every system connected to the grid will see a different voltage and therefore will be curtailed differently. The reimbursement of the lost energy must therefore be calculated individually for every system. As the AC voltage measurement inside the inverters is not very precise, it's not easily possible to predict the curtailment losses of the inverter.

PV inverters do not rise the grid voltage above the over-voltage protection limits set in the inverter. Independent of their age and grid code.

Every PCE connected to the grid is equipped with an over voltage protection function and could therefore theoretically without any update take part of such a system. However, the over voltage protection would disconnect the PCE from the grid and therefore lead to an on-off oscillation of the PV plant, which is highly undesirable. A desired voltage droop control function does not affect the power output until the voltage is close to the highest acceptable value in the grid. If the grid voltage exceeds this value, the PCE must reduce the power within a narrow voltage band. Dynamic voltage stability can be critical and depends on the control algorithms (precision) of the PCE and the distribution grid configuration. Figure 7 gives an example of an asymmetrical over-voltage volt-watt droop function, see also Chapter 5.5, Japanese example.

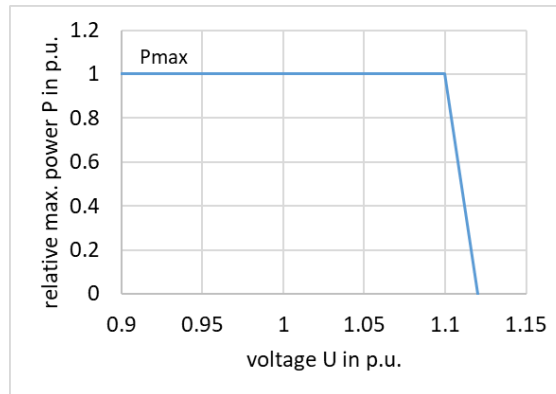

Figure 7: Example of an asymmetrical over-voltage volt-watt droop function

Trivia: Also this method has always been implemented in PV inverters, but as a protection function and not as an optimisation function. Therefore, inverters with old grid connection settings tended to switch on and off if they are connected to very weak grids with high voltages. This behaviour is not desired and often replaced with volt-watt control functions today. Yet it should be noted that PV inverters cannot – and never could, be the cause for grid voltages above the allowed limits, unless they show faulty behaviour.

3.2.4 Power Limitation According to a Signal from the Distribution System Operator (DSO)

In several countries, DSO require an interface to PV systems above a certain rated power to curtail their power output. These systems are normally only used in disturbed situations, e.g. if components of the grid are overloaded. Depending on the local regulations, the control interactions can be a simple on-off signal, a multi-stage signal or a more sophisticated control signal. Figure 8 shows an example of a four stage remote controlled curtailment, as it is implemented in some European countries, [17].

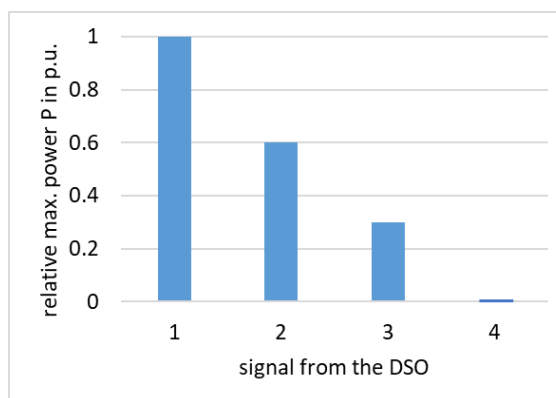

Figure 8: Example of a four stage remote controlled curtailment



Depending on the voltage level at which a PV system is interconnected, there are accordingly different curtailment requirements and strategies. The categorisation of PV systems is normally given in technical guidelines. To some extent, the cellular grid topology and coordinated, cascaded PV power management shall be considered. Regarding the large number of decentralised energy systems in the DSO responsible areas, special attention must be paid to the deployment process to avoid discrimination against small-sized prosumers.

Given the complexity of a specific use case, there are many possibilities for the implementation of power limitations on PV systems. Considering the control of Distributed Energy Resource (DER) in a microgrid (MG), PV curtailment can be performed in different fashions: centralised remote control, decentralised local control, or distributed control combining the advantages of the other two variants. The choice of control strategies depends on many factors, e.g. communication quality, device intelligence, local storage, cyber-security, privacy concerns etc. It's worth mentioning that distributed control is currently a research topic, which requires further development and engineering effort. In future distribution grids, the DER controllers are supposed to be coupled in a hierarchical control framework, more details about these control strategies and example implementation can be found in [18] and [19].

Another topic related to the power limitation by DSO is: how to determine the control setpoint when encountering overloading problems in the distribution grid. Rather than limiting the PV feed-in power of associated systems equally, a linear approach similar to the Voltage Droop Control could be used, one simple example is presented in Figure 9. In this case, the setpoint limit is determined by the DSO or an overlaying grid management coordinator based on the power flow calculation. For instance, the curtailment setting can be changed by DSO remotely.

Advanced PV curtailment in the sense of optimal control requires the application of numeric methods, e.g. optimal power flow and model predictive control, and also AI-technologies to boost the real-time computation for large-scale optimisation problems, these fields are currently research topics.

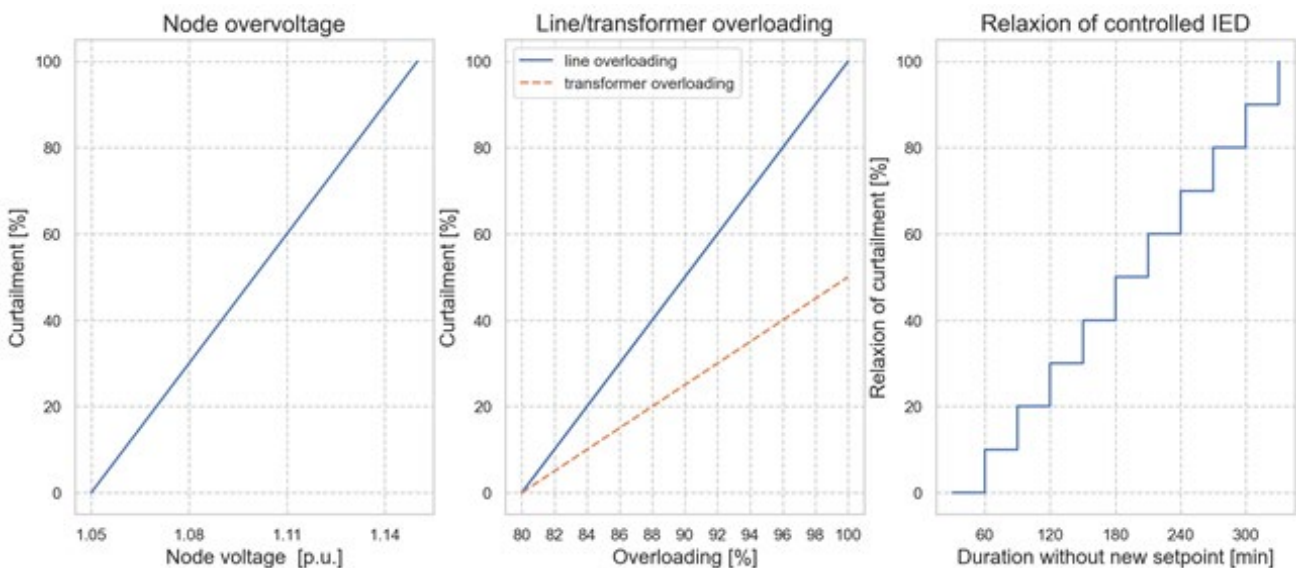

Figure 9: Examples of linear PV active power limitation and stepwise curtailment relaxation as respond to grid component overloading in an academic simulation environment



3.2.5 Power Limitation According to a Signal from the Transmission System Operator (TSO)

In the case of DSO-connected DER-induced or at least supported congestion in the transmission system, the TSO typically require the DSO to reduce PV and wind energy production. This cascading action in congestion management can be further distributed towards the lower voltage levels by the DSO. In Germany, this process is regulated within VDE-AR-N 4140 (also applies if initial requirement is send from a DSO directly to underlying further DSOs).

In the case of Japan, TSOs normally command the PV system interface (PCE) directly, and the PCEs are automatically controlled to reduce PV power production (see also Chapter 5.5, Japanese example.). This curtailment method is thus similar to the curtailment method in Chapter 3.2.4, just triggered by the TSO instead of the DSO. Especially in northern Germany this has been seen frequently for wind farms [20]., since their sizes have a relevant effect on the transmission system power flows.

3.2.6 Aggregated PV Power Curtailment

PV systems where power is sold to the market are sometimes connected to an aggregator (e.g. in Australia). This aggregator typically has / must have the possibility to reduce the power output of the systems. Although some aggregators theoretically could follow a production schedule, they simply switch off the PV systems if energy market prices are negative. More sophisticated control is applied to battery storage systems or combined PV + battery systems.

In southern Australia, aggregated PV system control has been introduced as an urgent measure to stabilise the system.

3.2.7 Optimisation-Based Curtailment Approaches in Grid Planning and Operation

Oftentimes, the use of active power curtailment (APC) in the functionality of peak shaving serves the time-limited operation of individual resources or small grid components with a grid bottleneck that is to be eliminated in the medium term. Causes can be, for example:

- Excessively long planning and approval processes in upstream networks (e.g. in the HV grid when new HV/MS substations are built), including mutual dependencies.
- Unclear medium-term grid requirements and corresponding expansion needs, if the actual realization of especially large requested RE projects is not certain (both the construction as such and final power and grid level of the interconnection point)
- Insufficient resources for timely expansion (own and third-party personnel, material), corresponding prioritization of measures
- Bundling of network expansion measures, e.g., when changing network distribution or replacing switchgear together with more powerful transformers
- Utilization of the remaining service life of old equipment
- Insufficient bundling of spatially close but temporally staggered RE projects.

In Germany, in the grid planning process system operators are allowed to curtail up to 3 % of the annual energy of each onshore wind and PV plant, according to the German Energy Act (EnWG §11), to ensure efficient and demand-oriented grid expansion [21]. For Transmission System Operators it is mandatory to consider active power curtailment in the grid development plan, distribution grid operators are free to apply APC in their planning process.

Application approaches promise different amounts of savings in network expansion depending on the data requirements and complexity of the used methods [22], [23]. In grid operation, it is likely



that power plants will be curtailed with more than 3 % annual energy, since the plants most sensitive to a bottleneck will be curtailed first for reasons of efficiency.

The contradiction between efficient curtailment (absorption of the largest possible amounts of electricity) and compliance with a certain limit of energy loss (e.g. 3% per generator as given in [24]) remains the greatest lever for the efficient further development of peak shaving. Especially in the MV grid, where voltage limitation is the most common bottleneck, it seems technically questionable to also curtail the plants close to the substation, although the plants further away could have a much higher influence on the voltage and also load the lines more in total. It therefore seems reasonable to question this contradiction between peak shaving and redispatch and, if necessary, to resolve it.

However, if peak shaving is used to serve as a consciously – i.e., "voluntarily" for economic reasons – used instrument of an optimized network planning, optimisation tools are necessary. An economic evaluation determining the actual balancing energy in operation is a solution that involves planning as well as grid operation and regulation. Other aspects further increase the effort and complicate the use of peak shaving, such as:

- Significant increase in the scope of reporting as part of Redispatch 2.0 [ref];
- Regulatory differences in treatment of investments (network reinforcement) and operational expenses (compensation for redispatch measures), complicating direct offsetting against each other;
- Still no consideration in the selection of the grid interconnection point in MV grids ;
- Enormous need for high-quality, up-to-date network and time series data, the regular procurement, preparation and processing of which is only possible with automated tools;
- Contradictory regulations of peak capping in case of limitations per individual plants, where in practice, however, similar plants with high impact would always be controlled (MV level). Non-discrimination and effectiveness are in direct contradiction here.

Based on the findings in the research project SpiN-AI [25], [26], [27–29] a further development of the framework conditions for peak shaving should be discussed. In the EU regulation, an alternative regulation to the per-generator limit is left to the member states from a RE share of 50% [30]. In some areas, peak shaving can temporarily absorb the expected "wave" of RE connections over the next 10 to 15 years, allowing faster grid connections and integration of larger amounts of electricity into the existing grid. .

Further potential of peak shaving exists in the combination with other optimization measures in the context of the NOVA principle in the grid expansion planning processes. Due to the dynamic application of APC, rarely occurring grid situations are less relevant for worst-case grid planning at the distribution level. If APC is combined with weather-dependent overhead power line ratings, synergy effects can be fully exploited. Figure 10 describes an example for a wind power plant. Nevertheless, the principle could similarly be applied for other renewables and especially PV systems.

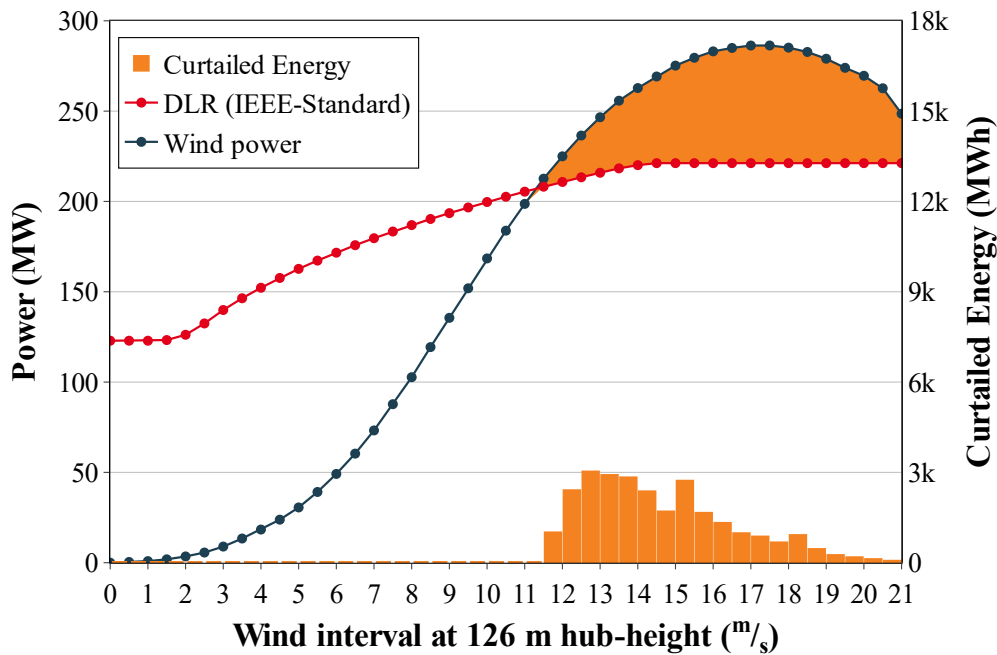

Figure 10: Combination of APC and DLR in a characteristic curve based approach [28]

Therein, the provided active power feed-in (black-blue) can be upscaled beyond the dynamic line rating (DLR) curve (red) until 3% of the annual energy are curtailed (orange area and bars) in the planning process. The amount of curtailed energy can be calculated with an iterative algorithm, in this example using the distribution of the wind speed for each wind class, to estimate the annual curtailed energy. This approach allows the calculation of new easy-to-use worst-case factors for the DSOs in their planning. The additional consideration of PV feed-in promises further potential in the utilization of existing transmission reserves of overhead power lines. Optimization methods like APC or DLR can increase the utilization of existing grid infrastructure and accelerate the connection of RE.

3.3 Communication Concepts and Requirements

The basic concept of communicating with PV systems consists of the specification of the communication interface (data model plus communication protocol), implementation of resilient communication infrastructure, selection of control parameters in the data model according to different functions and use cases, data engineering in associated systems, and also the handling of IT-security concerns.

In terms of centralised (remote, or online) PV power management, one communication partner at the field level could be the PV inverter, PV data logger, a control unit deployed by DSO, or a Home Energy Management System (HEMS); whilst on the other side, the remote communication unit could be a DSO SCADA, a grid cell manager. Speaking of decentralised (local, offline) control, the PV inverter still demands a communication interface to a local controller, which is one of the roles mentioned above.

The operation of a communication system gets much more complicated when multiple parties are allowed to access and control the PV systems using the same or different communication routes.



In this case the communication routes or the usage of one channel must be appropriately organised such that conflict and violation of priorities never happens.

Another requirement of the communication is the security in the sense of access control, data encryption, and IT-side system configuration. For example in Germany, the security is given by deploying systems and components of the Smart-Meter-Infrastructure (SMI), which allows for access/role control using the Public-Key-Infrastructure (PKI) and encryption of confidential data.

3.4 Priority / Choice of Most Suitable Control Mode

Different control approaches might contradict each other in some situations. While an aggregator might want to increase the power output of a curtailed system, the network operator faces capacity constraints and demands the system to run in curtailed mode. Fundamental priority control considerations are given in Figure 11.

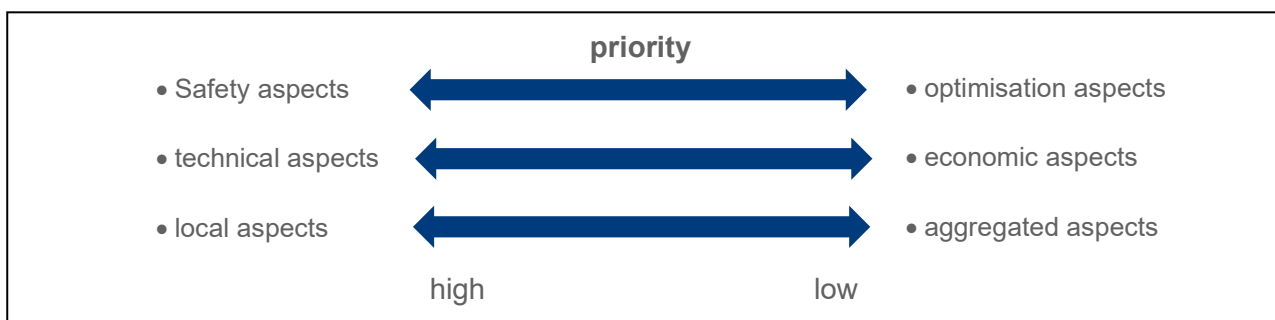

Figure 11: Fundamental control priority considerations

Three examples which correspond to Figure 11 are:

1. **Safety vs. optimisation:** A prosumer wants to feed energy into the grid due to high electricity prices, but the feed-in metering does not work due to a defect. The lack of approval for feed-in takes priority, which is why the prosumer is not allowed to feed in.
2. **Technical vs. economical:** An aggregator would like to ramp up power to follow high energy prices, but the TSO requires to switch off the system to respect grid constraints. The TSO must have priority.
3. **Local vs. aggregated:** The TSO requires maximum production to support the frequency, while the DSO requires curtailment to reduce the voltage. The voltage constraint should have priority, because frequency services can be obtained from other geographical areas too, whereas voltage services must be provided locally.

However, priorities are not always as clear as Figure 11 might imply. The following questions can be used to find appropriate priorities for control systems.

- What use cases are considered?
- Who has access to the system? Who should have access?
- Are there legal restrictions (e.g. grid operators shall not interfere with market players)?
- What are the consequences if one or the other signal is ignored?
- Who owns the assets? Who pays for it?
- Who has access to the system?
- Is there a “natural”, physical priority (such as a disconnection switch overrules always voltage support functions)? Is this the desired behaviour?
- What priority should scheduled functions have?



4 CONSIDERATIONS ON CURTAILED ENERGY

4.1 General considerations

From an energy and environmental perspective, energy curtailment should be limited. Depending on the level of PV penetration and the local situation, different measures can help to limit the amount of curtailed energy. Figure 12 illustrates different measures at different PV penetration scenarios. The measures can be described as follows:

1. **No measures:** In low PV penetration scenarios, no PV energy must be curtailed in order to integrate PV. As PV penetration rises, also the need for curtailment measures rises, in order to ensure secure and reliable system operation and to avoid overloading or operation outside of given technical limits (e.g. system voltages). Therefore, measures to enhance the hosting capacity have to be undertaken.
2. **Grid measures:** Depending on the grid topology and strength, measures on the grid such as reactive power control, tap changing transformers or grid reinforcement might be needed and helpful to limit the amount of curtailment losses in medium PV penetration scenarios. However, grid reinforcements are only a meaningful measure, if the power produced can be consumed at the time of production at another place in the grid. Hence, grid reinforcement can always solve distribution and transportation issues, but they can never solve all system wide issues. The most illustrative example is an insular power grid, where a stronger grid can never compensate for lack of load matching or storage. If the local/regional/system wide demand is overrun by the generation, additional measures have to take over.
3. **Demand side management:** If there's no sufficient consumption during the time of production, there's no point in reinforcing the grid. Load must be shifted from low production times (e.g. night time for PV) to high production times (day time for PV). Therefore demand and generation have to be aligned in further rising penetration scenarios.
4. **Storage:** However, load management has only a limited effect due to the often limited load shifting capacity (e.g. heating/cooling demands, continuing processes). In very high PV penetration scenarios, additional storage systems are needed to limit the amount of curtailment.

Yet it is not the goal to limit PV curtailment to zero. The nature of the flat start of all curves in Figure 12 is very typical for PV energy curtailment: If only a small part of the energy yield is curtailed, the share of PV in the electricity grid can be greatly increased without additional measures.

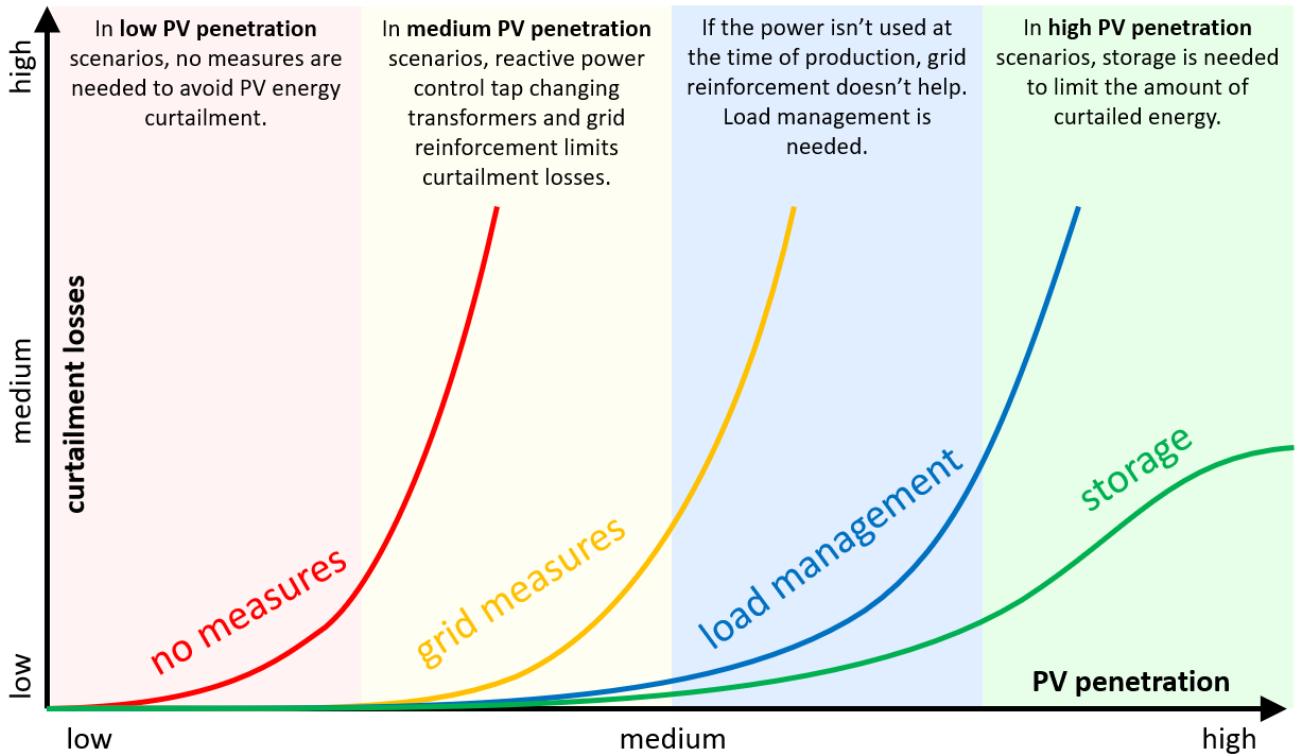

Figure 12: Hierarchy of measures to limit curtailment losses [1]

4.2 Example of Energy Curtailment Calculations

Depending on the location and the orientation of the PV modules, the curtailed energy for a given fixed sizing Ratio (SR, AC to DC ratio) varies significantly. Despite the fact the authors of this report recommend to limit the power at the POC and not at the PCE it is impressive to see, how little energy is lost if the SR is chosen far below $SR = P_{AC}/P_{DC} = 1$. Figure 13 shows what SR is needed if an energy curtailment loss of 3 % shall be targeted. Figure 14 shows the curtailment losses as a function of the Sizing Ratio for different module orientations. Both graphs are based on weather data in Switzerland.

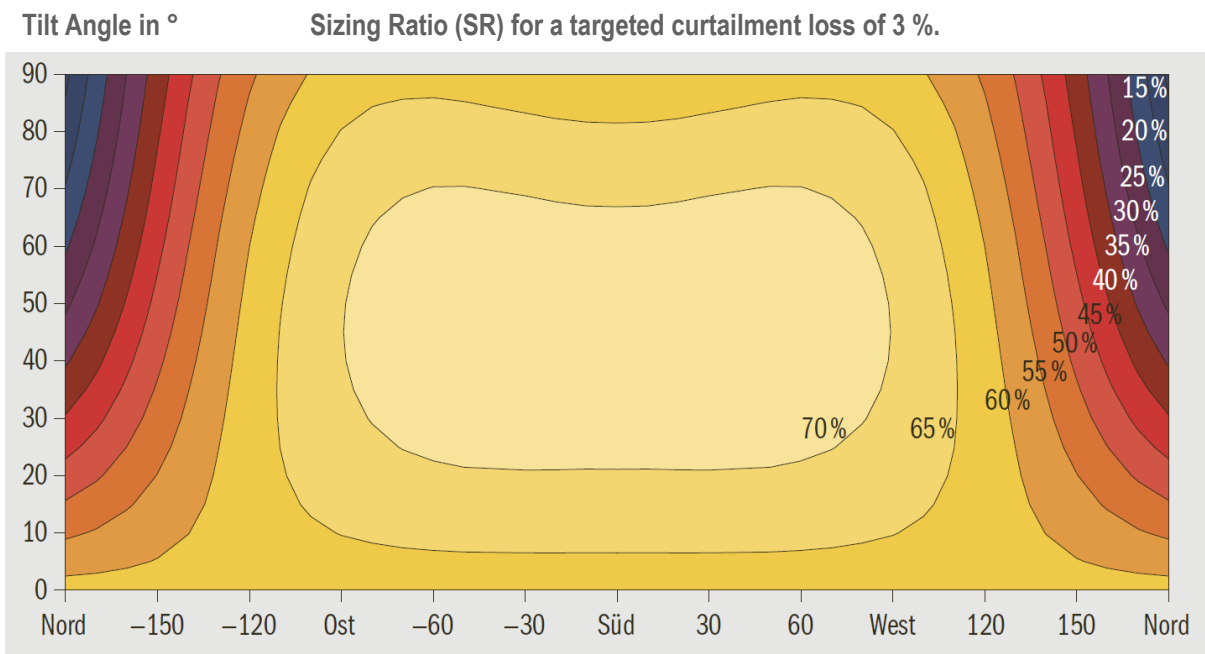

Figure 13: Required Sizing Ratio (SR, AC to DC ratio) to get 3% curtailment losses in central Europe (Switzerland, midlands) [31]

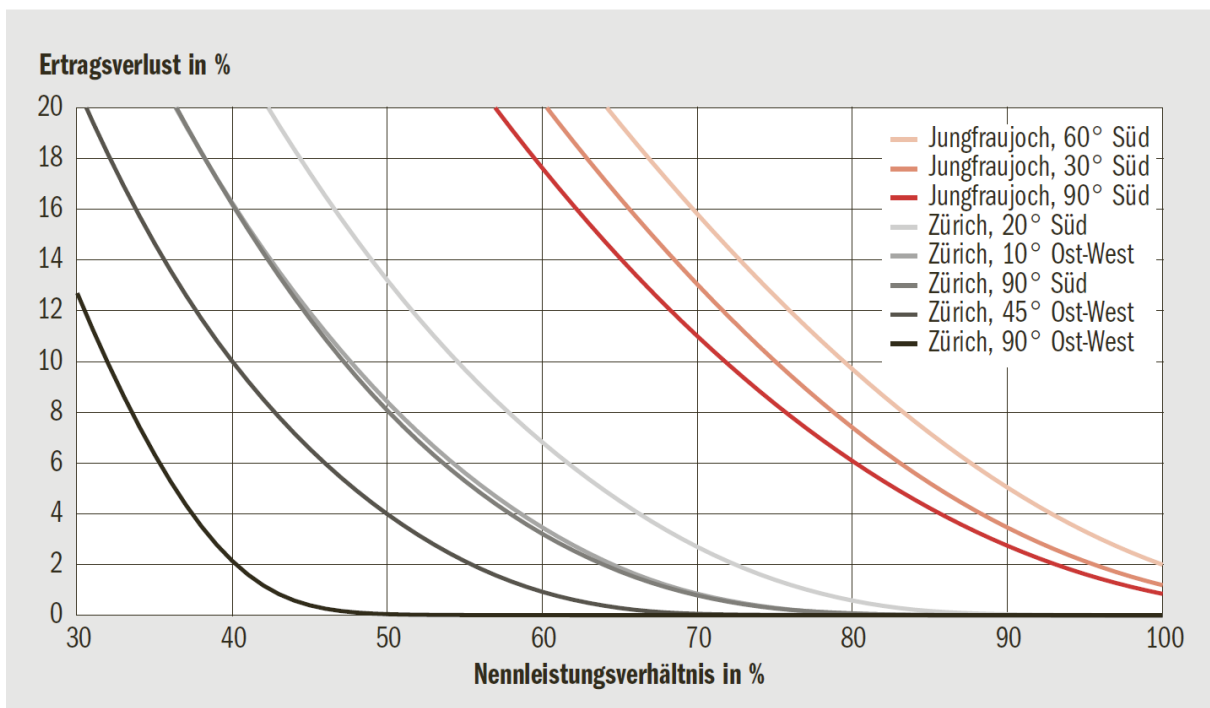

Figure 14: Curtailment losses at two locations in Switzerland for variable SR [31]



5 STANDARDS AND NATIONAL FRAMEWORKS RELATED TO CURTAILMENT

5.1 IEC

5.1.1 IEC 62786 Distributed Energy Resources Connection With the Grid - (Series of Documents)

After several countries such as Germany or the USA, but also the European Union (Cenelec) have implemented their national grid connection standards, IEC has released its first modern grid connection standard. Part 1 is technology independent, Part 2 covers additional requirements for PV systems. Active power management is covered by defining:

- Volt-Watt control: $P(U)$
- Frequency-Watt control: $P(f)$
- Remote control of inverters

5.1.2 IEC 63409 Photovoltaic Power Generating Systems Connection with Grid - Testing of Power Conversion Equipment (Series of Documents)

By the publication date of this report, the IEC 63409 series was not available yet. According to the authors, it shall basically cover the testing procedures for all functions described in IEC 62786-1 and -2.

5.1.3 IEC 61850 Communication Networks and Systems for Power Utility Automation (Series of Documents)

One of the widely used communication protocols in MV and LV power grids is the IEC 61850 standard series because of its extensive data model, comprehensive functionality, universal usability, high interoperability and definitions for communication architecture. IEC 61850 is a set of standards of IEC Technical Committee 57 (TC57) for electrical substations automation systems and DER integration. The main communication architecture concept in IEC 61850 is the creation of data objects and services independent of any particular protocol, or 'abstracting' them. This allows further mapping of the data objects and services to any other protocol meeting the data/service requirements. IEC 61850 provides a variety of advantages, including interoperability of devices from different suppliers, lower installation, configuration and maintenance costs, enhanced scalability and the possibility for further improvements of systems automation processes. It was originally developed for electrical substations LANs, so it mostly employs TCP/IP protocol and Ethernet link as a communication medium [32].

The standard documents IEC 61850-7-3 and IEC 61850-7-4 have clearly defined the Common Data Classes (CDC) and compatible logical node classes. One supplementary standard document, IEC 61850-7-420, provides enhanced DER compatibility with commonly used device types and numerous properties, especially data objects related to PV operation. The document IEC 61850-



8-1 further defines the application of MMS (Manufacturing Message Specification) as the standard service-mapping in a server–client form for TCP/IP-based telecommunication [33].

The IEC 61850-compliant data model is normally self-described and will have a hierarchic structure, making the conversion of PV characteristics to IEC 61850 parameters as well as the integration in the existing grid model on the DSO side relatively straightforward on the application level. For the deployment of PV curtailment methods, only a small amount of IEC 61850 data objects and data attributes is required.

5.1.4 IEC 60870-5-104 Telecontrol equipment and systems - Transmission protocols

IEC 60870-5 is the state-of-the-art tele-communication protocol used by many DSOs. It provides signal-oriented telegram for telecontrol equipment and systems using TCP/IP, but has no specific implementation for DER such as PV systems. However, several device manufactures have implemented data interfaces between fieldbus protocols (like Modbus TCP) and IEC 60870-5-104, such that the remote control center can establish tele-communication channel for PV monitoring and feed-in power management.

5.2 CENELEC

5.2.1 EN 50549 Requirements for Generating Plants to be Connected in Parallel with Distribution Networks (Series of Documents)

5.2.1.1 Overview

EN 50549-1 and -2 are among the first transnational grid connection requirements document published. In late 2022, Part 10 of the same series was published. Part 10 defines testing procedures for the functions described in Part 1 and Part 2.

The structure of the documents and the functions described in the documents are similar to the IEC 62786 series. However, in contrast to the IEC 63409 series, the EN 50549 series is technology independent and does not only cover photovoltaics.

5.2.1.2 Active power control requirements

Related to active power management, the EN 50549-1 (requirements for low-voltage connected generating systems) and EN 50549-2 (requirements for medium-voltage connected generating systems) define requirements for active power remote control, which have to be met by “Type-A” and “Type-B” power generating modules. In detail, they need to be capable to reduce their active power output according to a setpoint remotely provided by the DSO. The setpoint can be adjusted in the full range from the maximum active power to the minimum regulating level in steps of 10% of the nominal power. The output power shall be reduced within an envelope “not faster than 0,66 % Pn/ s and not slower than 0,33 % Pn/ s with an accuracy of 5 % of nominal power”.

In addition, the EN 50549-1 and -2 both state that “generating plants/units are allowed to reduce active power output as a function of this rising voltage, in order to avoid disconnection due to overvoltage protection”. However, this requirement is not mandatory and no further details related to the characteristics or the dynamic response are specified.



5.2.1.3 Implementation of the remote communication

According to EN 50549, generating plants above a threshold to be determined by the DSO and the responsible party shall provide capabilities to be monitored by the DSO or TSO as well as receive operation parameter settings from the DSO or TSO.

The recommendation is to use standardised communication and protocols defined in relevant technical standards: Specifically, e.g. EN 60870-5-101, EN 60870-5-104, EN 61850 and in particular EN 61850-7-4, EN 61850-7-420, IEC/TR 61850-90-7, as well as EN 61400-25 for wind turbines and relevant parts of IEC 62351 for relevant security measures are mentioned. Further details on the parameters and signals can be found in the EN 50549-2 Annex B.

5.3 Austria

5.3.1 Framework

In Austria, the requirements for the grid-connection of generating systems are governed by the “Technical and organisational Rules for Generating Plants” (“TOR Erzeuger”), issued by the national regulatory authority for the electricity market (E-Control). The TOR are an integral part of the contract between the user and the operator of electricity networks and are applied to all connections of generating plants, including electrical energy storage systems.

For the connection of generating plants, different rules apply depending on the generator type as per the definitions of the European Network code “Requirements for generators”. In Austria, generating systems up to 250 kW are categorised as “Type A”, systems from 250 kW up to 30 MW are of “Type B”.

5.3.2 Active power control requirements for Type A generating systems (<250 kW)

According to the TOR, Type A generating systems are not required to provide remote control of active power.

To ensure the upper limit value of the grid voltage according to EN 50160 (110% U_n) is complied with, generating systems with a grid connection point in the low-voltage grid have to provide a voltage-controlled active power control $P(U)$ function. For inverter based generating systems, the $P(U)$ controls integrated in inverters are to be used.

The $P(U)$ control can be implemented with either one of the two options indicated in the figure below. Option a) defines a limitation of the active power which can be injected into the grid as a percentage to the rated power. For option b) the active power is reduced linearly by ΔP in relation to the instantaneous feed-in power P_{Knick} (active power at the time of exceeding U_{Knick}).

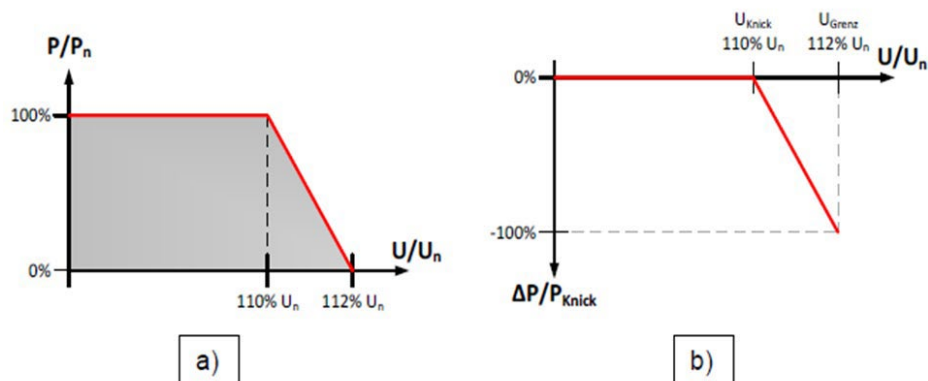

Figure 15 P(U) functions as required by the Austrian Technical and organisational Rules for Generating Plants for low voltage connected plants

The dynamics of the P(U) control corresponds to a first-order filter (PT1 element) with a configurable time constant between 3 s and 60 s, whereby a time constant of 5 s must be set as standard. Further details (e.g., related to voltage references and phases) are not specified.

5.3.3 Active power control requirements for Type B generating systems (≥ 250 kW)

According to TOR, Type B generating systems are required to provide capabilities to allow the remote control of active power.

For generating systems with a registered capacity of < 1 MW, the active power setpoint is provided as defined steps (e.g., 100%, 60%, 30% and 0%), which have to be achieved within 1 min.

For generating systems ≥ 1 MW, a remote-control interface based on common communication standards (e.g., IEC 60870-5-101 or IEC 60870-5-104) has to be provided.

In addition, Type B generating systems must provide real-time generating data in line with the European System Operation Guideline (Commission Regulation (EU) 2017/1485).

In practise, most distribution grid operators will require the installation of a plant-controller for new Type B generating systems, which implements the remote-control requirements as well as the real-time data requirements.

5.4 Germany

5.4.1 VDE AR-N 4105

The first edition of the German VDE AR N 4105 issued in 2011 was among the first standard documents describing grid support functions and thus curtailment functionalities of PV inverters. The VDE 0124-100 described the corresponding testing procedures. A more modern holistic approach is found in the current edition of the VDE-AR-N 4105 from 2018, where all currently required grid support functions are described. As Germany was among the first countries to release such a document it served as source of inspiration for many other standards such as the EN 50549 and the IEC 62786.



Even today, the AR-N 4105 offers some levels of detail regarding active power management which cannot be found in several other documents

- It defines control priorities.
- It states that PV system which sell their power to the market must increase their power output in case of an underfrequency event, if they run in curtailed mode. As of today there is no experience with this functionality.

5.4.2 Communication and Smart Grid Aspects

In Germany, the grid communication to PV systems has been seen as one fundamental element of the future smart grid operation, technical committees and legislators have addressed this point in several regulatory documents.

The German Federal Office for Information Security (BSI) has established the technical guideline series TR 03109 [34] in the past years to specify the certification and operation of the Smart-Meter-Gateway (SMGW), Controllable Local System (CLS) control unit and SMGW-Administration (GWA). This series is still under further development to include more grid- and market-supporting functions. For instance, the Metering Point Operation Act (MsbG) was established in 2016 along with the Law on Digitalisation of the Energy Transition (Gesetz zur Digitalisierung der Energiewende, GDEW) [35]. It raised the fundamental role of smart meter components and systems in the era of the Energy Transition and defined the application of SMGW as the key element of a standardised, secured communication gateway.

According to the § 9 section (1) of the novel German Renewable Energies Act (EEG 2021) [21] all PV systems in Germany with an installed capacity over 25 kWp must be equipped with a technical facility to ensure that at any time, the PV system can:

- provide the actual feed-in energy
- be remote controlled by step or step less

Besides, according to the § 9 section (1a), a grid-interconnected PV system with an installed capacity between 7kWp and 25kWp, which is coupled with a controllable load, must be equipped with a technical facility to ensure that its actual feed-in energy can be retrieved at any time.

In connection with § 30 of the MsbG, the technical facility mentioned in EEG 2021 § 9 should work together with a Smart-Meter-Gateway, which is the vital component of the TR 03109 series and is supposed to be massively rolled out in the coming years. Regulated by the new amendment EEG 2023 [36], for new installations up to and including 25 kWp commissioned after 14 September 2022, the 70 % rule has been removed; starting from 01. January 2023, the limit is also removed for existing installations up to and including 7 kWp.

As one necessary supplementary of the Smart-Meter-Infrastructure, the role of CLS control units and the associated management system has been defined in the TR-03109 series. In the past, one of the few technical guidelines is the recommendation for CLS control unit published by VDE/FNN (Verband der Elektrotechnik, Elektronik und Informationstechnik - Forum Netztechnik/Netzbetrieb) [37], which suggests the utilisation of the standard series IEC 61850 for WAN-communication and provides data model template for further development. There was almost no legislative regulation for CLS otherwise. Fortunately, the situation has been changed along with the establishment of the new version of §14a EnWG (01.01.2023) [38], which provides for a reduction of the grid fees for those consumers who have concluded an agreement with the grid operator on the grid-oriented control of controllable consumption devices or grid connections with controllable consumption devices. The §14a does not affect the curtailment of PV systems directly,



but the new regulation will boost the development and deployment of CLS-components, applications and supporting systems, which is beneficial for the PV branch.

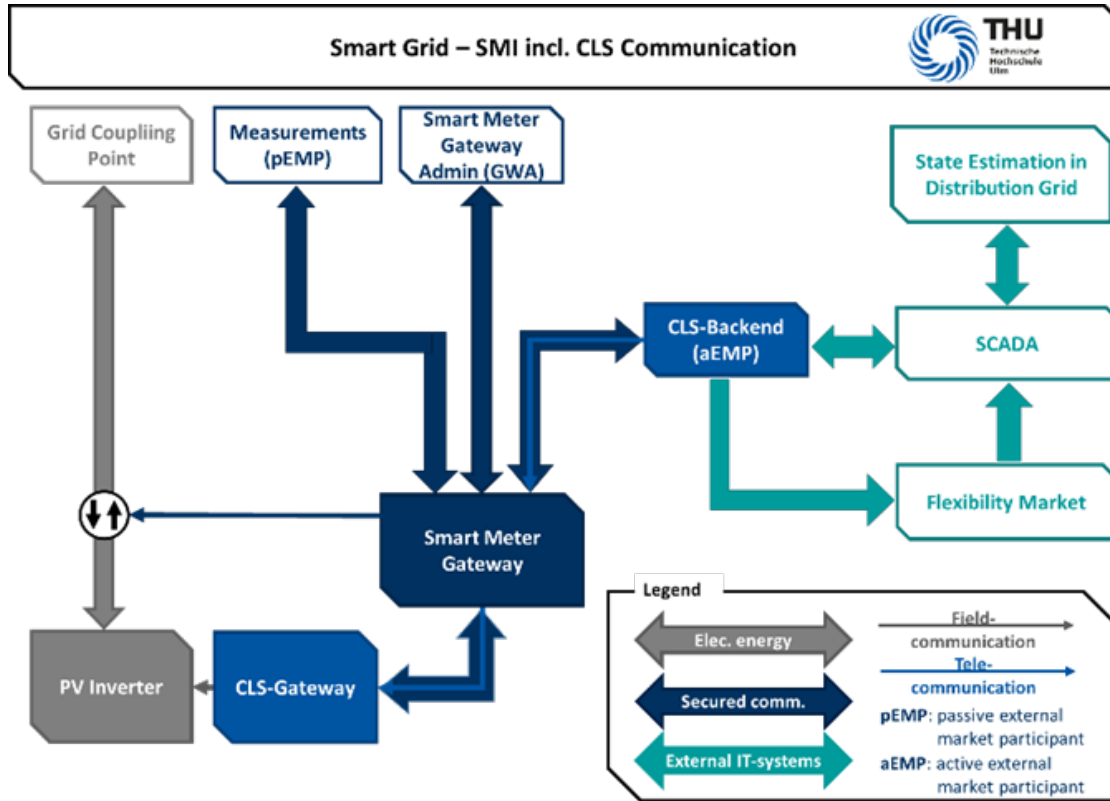

Figure 16: Schematical representation of the Smart-Meter-Infrastructure and its components deployed in the Smart Grid Lab at Ulm University of Applied Sciences

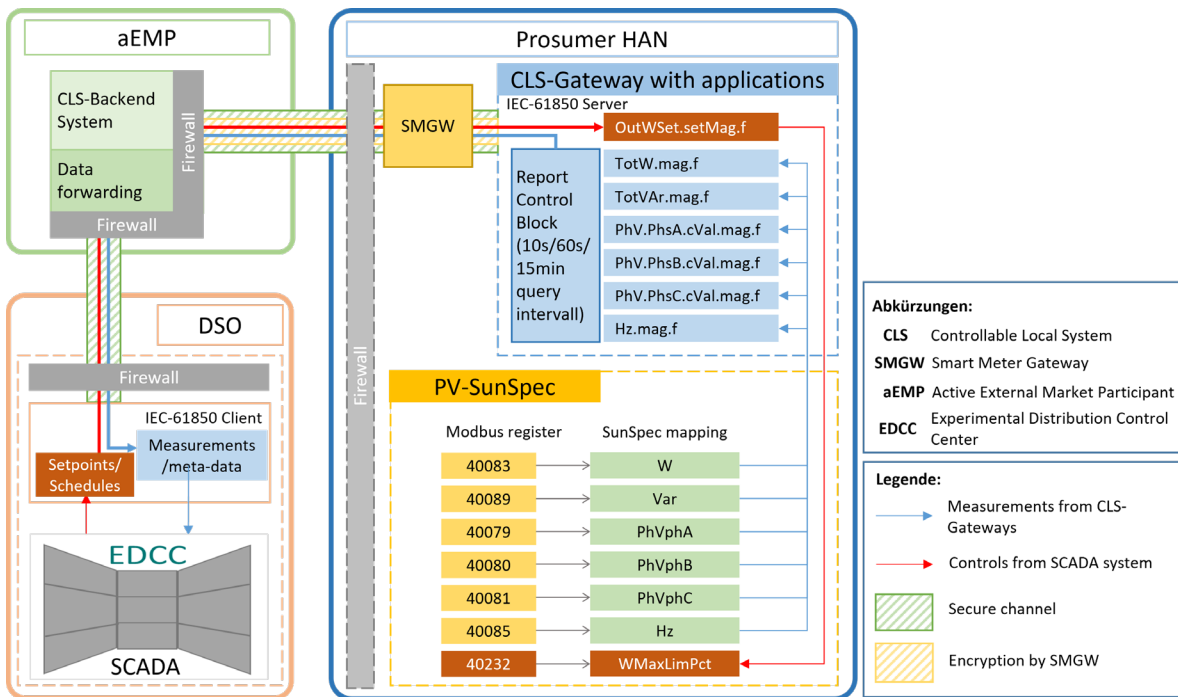

Figure 17: Representation of the communication architecture and PV curtailment procedure utilising a CLS-gateway according to the German Smart Meter Infrastructure

When linking the electric market and the physical grid at the technical level, the complexity of the overall system and the information to be exchanged increases with the number of authorised participants. The VDE FNN working draft from the point of view of the coordination function (KOF) at the operational level supports the authorised participants in bundling the information necessary for them in each case [39]. It is a translator and mediator between market requests and grid requirements, so that safe and reliable grid operation can be maintained even if controllable systems are marketed across the board at lower voltage levels. The KOF at the operating level is used for the coordinated control of generators and consumers and plays an important role in avoiding critical grid conditions. In addition to the contradiction-free control of customer plants (collision avoidance), the KOF also leads, above all, to an integrated exchange of information between the players involved. By providing the services planned by the market players, the network operator is enabled to evaluate possible restrictions in the network in advance, and then report this information back to the market players. The coordination function at the operating level completes the infrastructure of the smart metering system, which has always been the focus up to now, by providing a standardised control function towards a holistic smart grid infrastructure. This makes flexibility available to the energy market and grid operation.

Since an expansion of the distribution grids to comparatively few hours of high simultaneous power consumption is not considered economically sensible, the legislator has introduced the concept of "grid-serving control of controllable consumption facilities", as addressed in the application rule VDE-AR-E 2829-6-1 [40]. This concept is still based on small-scale control of facilities and focuses solely on consumers. This limitation to electrical consumers is too narrow in that "customer facilities" can include energy producers as well as battery storage. The installed generation and storage capacities are constantly changing due to regulatory and subsidy changes and lead to further changes in the load situation in the grid. In the future, for example, additional storage



capacity could be made available to the grid through bidirectional charging. For this purpose, VDE application rule AR 2829-6 describes a possible implementation of power control at the grid connection point using a communication protocol by one or more "controllable customer systems". In accordance with the addressed technical boundary between the electrical low-voltage distribution network and the energy drawing or producing "customer installation", this communication protocol generally describes the interface at the property boundary of the connection user. Grid-relevant and other control tasks have different requirements at the interface to the "controllable customer facilities", so that the control tasks must be differentiated. A possible implementation using SPINE is described in the separate application rule [VDE-AR-E 2829-6-2] [40], which contains information on the actors and SPINE data models as well as XML examples. For local communication within the property between the energy management system and individual plants, the EEBus protocol can also be considered.

In addition, the Protocol "Open Automated Demand Response" (OpenADR) consistently conveys the demand response signals to consumers (business or residential) from the system operator, facilitating a timely and predictable response, while allowing choices by the end consumer. Based on the OASIS Energy Interoperation Standard, the OpenADR 2.0 a and b Profile Specifications provide specific implementation-related information to build an OpenADR-enabled device or system [41].

As of October 1, 2021, the new redispatch system will apply in Germany according to the current version of the EnWG, which practically implements and concretizes the feed-in priority for electricity from renewable energies (RE). In this context, the RE minimum factor is used as the basis for determining the uniform imputed RE price, which is used to determine the imputed costs of the respective measures to reduce the priority-entitled active power generation of plants (see Section 3 No. 1 EEG). Measures for the reduction of RE generation are to be applied with their imputed costs in the selection decision of the overall most cost-effective combination of measures instead of the actual costs (Section 13 (1) sentence 2 EnWG). The imputed RE price is to be determined uniformly for all RE plants in such a way that a reduction in the active power generation of RE plants only takes place if, as a rule, at least a multiple of the reduction in the generation output of non-priority generation can be replaced as a result. The minimum RE factor to be set quantifies this ratio. This means that the lower the RE minimum factor is, the lower the uniform imputed price for the output reduction of RE plants and the more likely RE plants will be called upon for negative redispatch.

5.5 Japan

5.5.1 Curtailment scheme

5.5.1.1 Curtailment rule

Renewable generation curtailment, also called "output control" in Japan is established due to the constraints of supply and demand balance and network capacity.

Output control activated when the amount of power generation exceeds the amount of demand. When the FIT act came into force in July 2012, it stipulated that output "curtailment" due to supply and demand balance constraints would be limited to 30 days per year without compensation for each power generation facility, and initially the actual output control was estimated for those with an output of 500 kW or more due to the limited implementation of a remote output control system. And later, due to the rapid growth in variable renewables (see also APPENDIX A), renewables of



10 kW or more to be connected to the grid after January 2015 were specified for annual output control without compensation limited to 720 hours for wind power generation and 360 hours for PV power generation. In addition, it was stipulated that unlimited output control would apply to renewables connected to areas where the amount of connected power had already exceeded an allowable level. At the same time, the introduction of a remote output control system when connecting PV and wind power generation with reverse power flow has become a requirement in each TSO area. Under these circumstances, as the mass introduction of PV and wind power generation is progressing nationwide, unlimited and no compensation curtailment rule has been applied in all TSO areas of Japan since April 2021.

In order to maintain the supply and demand balance, the procedure for output control is ordained by laws and regulations. First, reduce the output of thermal power generation, then operate pumped-storage power generation, and thirdly, exchange power between TSO areas through interconnection lines. If the amount of power generated still exceeds the amount of demand, the output of PV power generation and wind power generation is controlled after the output of biomass power generation is curbed.

5.5.1.2 Curtailment

On 13 October 2018, in the TSO in Kyushu Island made the first renewable generation curtailment in four main islands of Japan. As shown in Figure 18, 0.93 GW of PV and wind generation were restricted under the following conditions at 12 p.m.: 7.3 GW of power demand, 4.5 GW of baseload generation, 2 GW of thermal generation, 1.8 GW of energy storage by pumped storage hydropower plants, and 1.9 GW of power export via an interconnection to a nearby TSO area Figure 18.

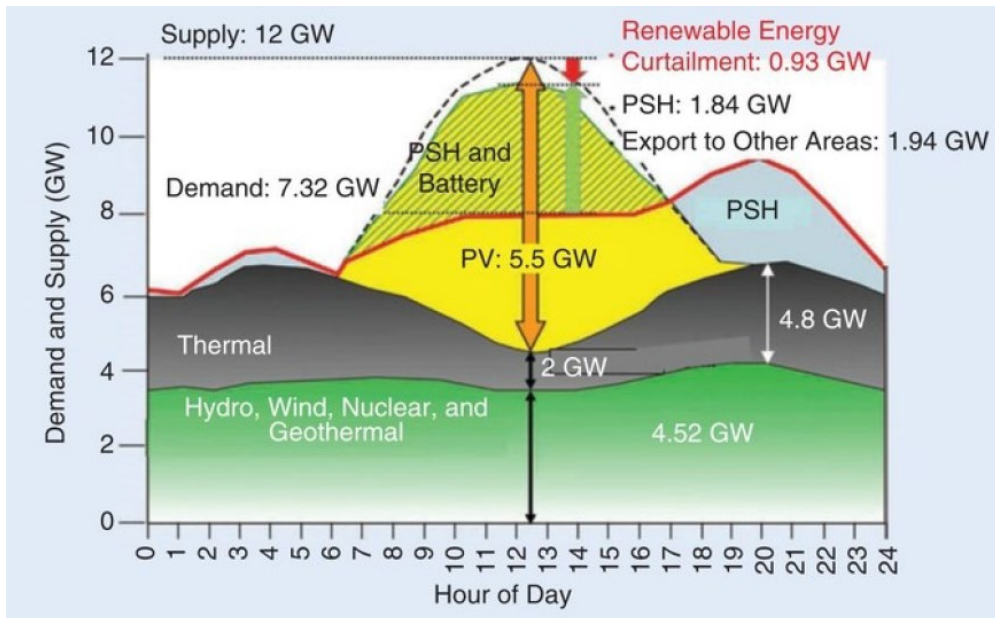

Figure 18: The demand and supply operation on 21 October 2018 [42]

In Japan, under the national policy to increase deployment of renewable energy, the renewable energy curtailment is managed by monitoring the practices, establishing new countermeasures to reduce curtailment and to maintain stable and economic operation of power systems in government committees including the Network Working Group.



In the Network Working Group, where issues and operational policies are discussed, the curtailment practices and outlooks are reported by TSOs. Figure 29 depicts the curtailment practices of each TSO area. The curtailment which occurred in 2018 continued only in Kyushu, with maximum kW and annual curtailed energy (kWh) changing according to changes of balancing situation including renewable energy deployment, improvement of generation forecasts and operational procedures, and adoption of more remote control functions on PCSs. In 2022, the curtailment occurred in 4 other areas than Kyushu, although the curtailed energy is small as that of Kyushu in 2018.

Table 1: Outlook of the Supply and Demand Balance Curtailment [43]

Area	Item		FY2018	FY2019	FY2020	FY2021	FY2022
Hokkaido	Maximum curtailment capacity (MW)	Total	-	-	-	-	2.72
		PV	-	-	-	-	2.14
		Wind	-	-	-	-	0.58
	Curtailment ratio		-	-	-	-	0.03%
Tohoku	Maximum curtailment capacity (MW)	Total	-	-	-	-	9.14
		PV	-	-	-	-	7.35
		Wind	-	-	-	-	1.79
	Curtailment ratio		-	-	-	-	0.36%
Chugoku	Maximum curtailment capacity (MW)	Total	-	-	-	-	6.52
		PV	-	-	-	-	6.16
		Wind	-	-	-	-	0.36
	Curtailment ratio		-	-	-	-	0.16%
Shikoku	Maximum curtailment capacity (MW)	Total	-	-	-	-	3.4
		PV	-	-	-	-	3.12
		Wind	-	-	-	-	0.28
	Curtailment ratio		-	-	-	-	0.58%
Kyushu	Maximum curtailment capacity (MW)	Total	9.04	10.02	10.88	11.54	11.54
		PV	8.53	7.35	10.29	1.091	1.09
		Wind	0.51	1.79	0.59	0.63	0.63
	Curtailment ratio		0.90%	4.00%	2.90%	3.90%	3.00%

Note: Curtailment ratios of FY2022 are the estimation by TSOs.

5.5.1.3 Countermeasures and future output curtailment

In Japan, for the massive deployment, countermeasures to reduce output curtailment are continually pursued by all stakeholders in multiple aspects.

Improvement of generation and demand forecast and system operation by TSOs is the base for curtailment reduction. For better balancing, in addition to the existing pumped storage, battery storage and demand shift are deployed gradually. In the supply aspect, thermal generators are expected to decrease of a minimum operational output level. For better trade between TSO areas, expansion and reinforcements of interconnections are studied, planned and being implemented.



Table 2 depicts an outlook of renewable generation curtailment due to supply and demand constraints based on assumed for 2031 in Japan. The PV and wind capacities of each TSO area in 2031 are based on the Electricity Supply Plan published by TSOs for from 2022 to 2021. The total capacities of PV and wind are assumed capacity increase of PV and wind from 67.8 GW and 4.9 GW in 2022 to 105 GW and 27 GW, respectively.

In the table, following countermeasures are assumed:

- Balancing: Battery of a kW capacity of 10% the minimum demand of each TSO area with 6 hour storage capacity
- Supply: Minimum outputs of thermal plants are reduced from 30% or 50% of a rated capacity to 20% (40% for biomass generation)
- Interconnection: addition of Hokkaido - Tokyo (4GW) and reinforcements of Hokkaido - Tohoku (0.9 -> 1.2 GW), Tohoku – Tokyo (5.73 GW -> 10.28 GW), 50Hz/60Hz (2.1 -> 3.0 GW), Kyushu - Chugoku (2.38 -> 5.16 GW).

Table 2: Outlook of Output Curtailment the Supply and Demand Balance constraints in 2031 [43]

Counter measures			Hokkaido	Tohoku	Tokyo	Chubu	Hokuriku	Kansai	Chugoku	Shikoku	Kyushu	Okinawa
Demand and supply balance	Base		53.6	54.2	3.4	2.8	4.2	3.8	25.5	2.8	26	0.87
	Battery with 10%-kW min. demand and 6-hour storage	(Level)	53.4	49.2	2.9	1.6	3.6	3.4	19.5	1.6	20	0
		(Change)	-0.2	-5	-0.5	-1.2	-0.6	-0.4	-6.0	-1.2	-6	-0.87
Supply	Reduction of thermal minimum output: 30/50% to 20% (Biomass 40%)	Level	43.5	41.5	0	1.8	2.9	0.6	13.4	2.3	23	0
		Change	-10.1	-12.7	-3.4	-1.0	-1.3	-3.2	-12.1	-0.5	-3	-0.87
Interconnection	100% of the master plan	Level	1.7	27.4	-	-	-	-	-	-	15	-
		Change	-51.9	-26.8	-	-	-	-	-	-	-11	-
	100% of the master plan	Level	0	11.2	-	-	-	-	-	-	9	-
		Change	-53.6	-43	-	-	-	-	-	-	-17	-

5.5.1.4 Output curtailment due to network congestion

Output control based on network constraints of operational transfer capability or “network congestion” is performed on the renewables which are connected on the condition that its output would be controlled when network congestion is forecasted. Even if there is no free capacity in the transmission system, the new power generation can be connected long before upgrading a transmission and a distribution system. This kind of connection is called "non-firm connection", and since 2021 all TSOs have been accepting applications nationwide for the renewable connection to the trunk transmission systems (The highest and second highest transmission voltage, typically 500kv and 275kv) that have no free capacity. From April 2022, non-firm connection has been applied to all trunk transmission systems regardless of whether there is free capacity. And since April 2023, it has started to accept applications on the connection to the remaining transmission systems or local transmission systems (typically 22kv to 154kv).

To handle network congestion in consideration of safety, energy security, economic efficiency and environment (S+3E), etc., it was agreed that TSOs conduct control of non-firm power sources according to merit orders (re-dispatch method) in December 2022.



"N-1 power supply restriction (operation)" has also been started to expand the operational capacity of transmission lines, etc., which has been reserved for emergencies, provided the relay system will trip the power supply in the event of a single equipment failure (N-1).

Figure 19 provides an overview of the hierarchy of grid congestion management.

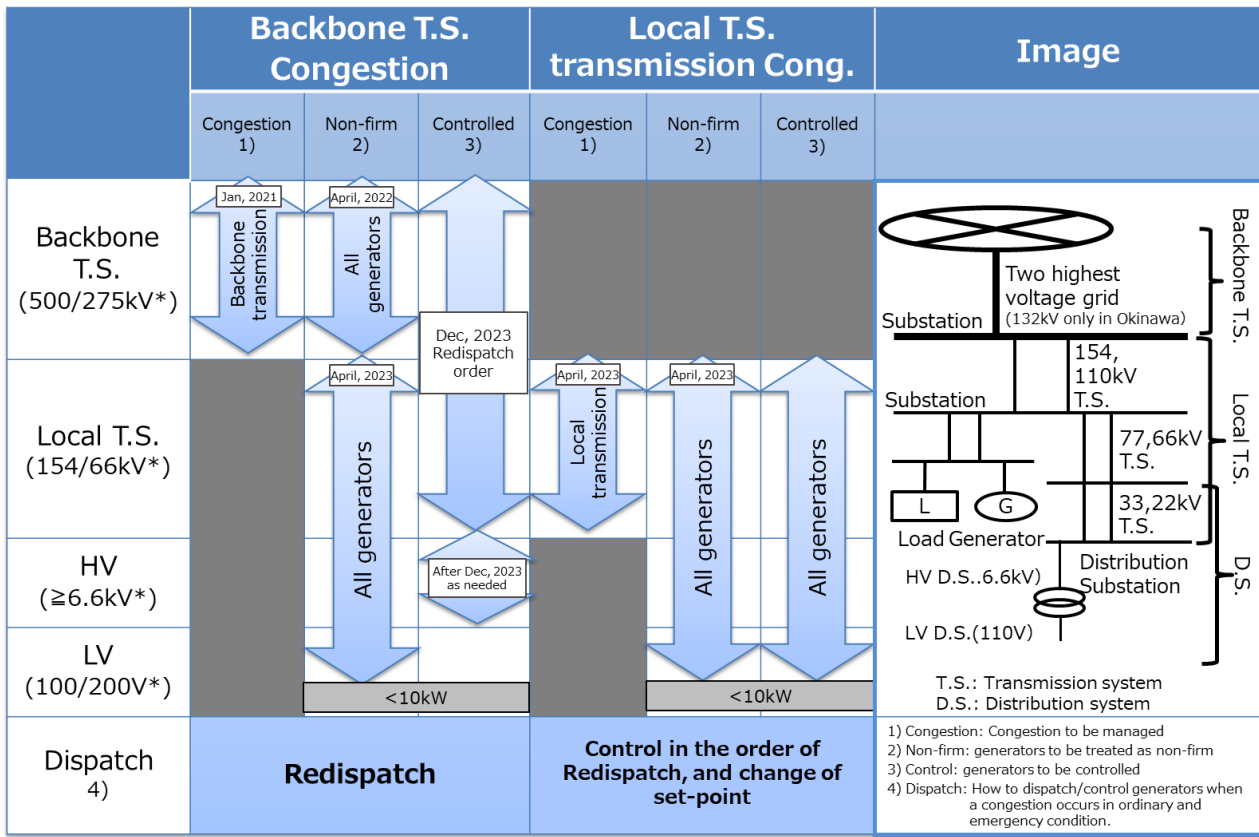

*Voltages are examples in case of TEPCO

Figure 19: Staged application of network congestion management [43]

5.5.2 Communication systems used

Output control methods include online control and offline control. Online control is for TSOs to remotely control power generation facilities via the Internet or dedicated communication lines. Offline (manual) control is for a generation system without online control system, where a system operator of a power generation company (a third-party company) controls power output according to an instruction from a TSO via telephone, email, etc.

For grids of 60 kV or more, it is a requirement for grid connection to take in power generation information through a dedicated communication line to ensure security against external threats according to Japan's grid interconnection code.

After 2022, for a new connection of PV and wind power generation 10 kW or more including all non-firm power sources, it is imperative to install devices such as PCSs with output control functions necessary for online control.



The technical specifications and data transmission specifications of these PCSs with output control functions are designated by each TSO. Among non-firm power sources, generators (rotating machines) other than PCSs are also required to have facilities configuration that has equivalent functions.

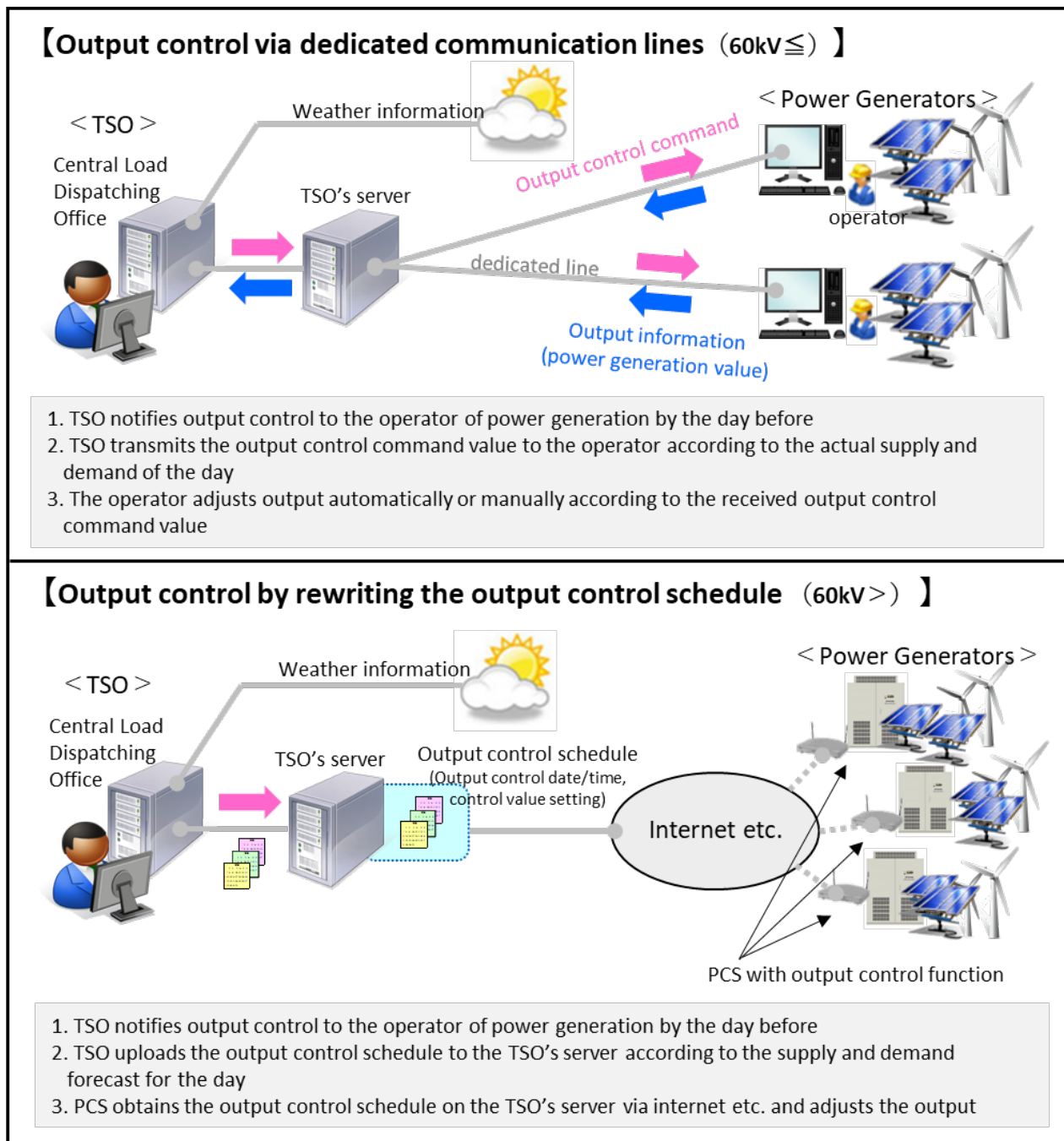

Figure 20: Example of online output control [44]



Compared to offline control, online control enables flexible operation that is closer to real supply and demand and is expected to reduce the amount of generation energy loss by output control. Therefore, in order to further expand the introduction of renewables, it is important to make output control on-line while ensuring fairness among business operators.

Therefore, since 2022, a mechanism has been introduced in Japan whereby online control companies perform output control that is supposed to be done by offline control companies and receive compensation at the normal purchase price assuming that the offline control companies have actually conducted it online.

This scheme currently applies only to a sufficient amount of on-line PV systems to allow alternative control.

5.5.3 Active power management to comply with voltage constraints of distribution grid

In Japan, receiving point voltage (V_d) of low voltage customer must be restrained within $101\pm 6V$ in accordance with Japanese Electric Utility Industry Law. Distributed power generation such as PV systems should have functions to restrain the voltage rise if the voltage may exceed the allowable limit by reverse power flow.

Constant power factor control is regarded as appropriate method to restrain the voltage raise and curtailment of distributed generation system such as PV. Figure 21 shows typical method for restraining voltage rise by controlling active and reactive power of PCS.

The flow of the voltage restraining method is as follows.

1. At first, PCS monitor the voltage (V_d) of receiving point of low voltage customer and detect whether the voltage exceed the upper limit or not.
2. If V_d exceeds the upper limit and power factor (P.F.) of the PCS of distributed generator such as PV is above 0.85 which is the allowable lowest power factor of distributed generators according to Grid Interconnection Guideline for Ensuring of the Electric Power Quality, then increase the reactive power (Q) of PCS until the voltage V_d is restrained within allowable level or P.F. reaches 0.85. If P.F. reaches 0.85 and voltage V_d still exceed the upper limit, then decrease the active power (P) of PCS until voltage V_d is restrained below the upper limit.
3. If voltage V_d is below upper limit and restrained value of active power (P) of PCS is not 0, then increase the active power (P) of PCS until restrained value of active power (P) becomes 0.
4. If voltage V_d is below upper limit and P.F. is not equal to predefined value ($\cos\theta_{ref}$), then decrease the reactive power (Q) of PCS until the P.F. reaches $\cos\theta_{ref}$.

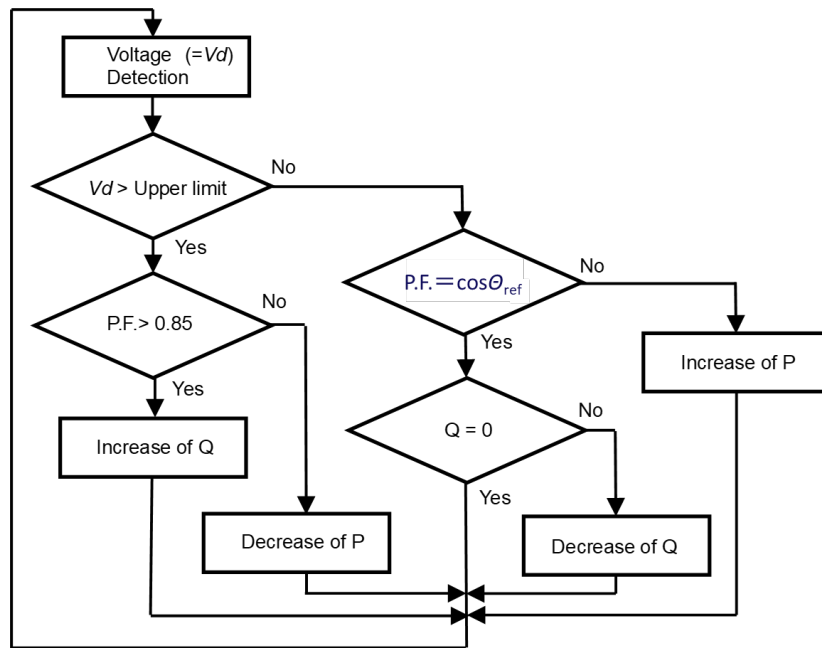

Figure 21: Typical active and reactive power control method for restraining voltage rise in low voltage distribution grid

In above method, typical constant power factor $\cos\Theta_{ref}$ is 0.95 but may be modified according to the consultation with distribution grid operator.

5.6 Morocco

5.6.1 Rules Regarding Curtailment

Morocco is pursuing an ambitious energy transition pathway with the goal of producing 52% (20% solar, 20% wind, 12% hydro) of its electricity demand by 2030 with renewable energy sources and 80% by 2050 [46].

The regulatory framework, which serves as a foundation for all sector participants, is essential to the strategic plan. A regulatory framework to allow grid access has been established by law with the supervision of government agencies (AMEE, ANRE, MASEN, ONEE ...). In this context, the National Electricity Regulatory Authority (ANRE) was created in 2015 following law n°48.15 [47], with the mission to ensure equal access to the national transmission system and distribution systems, set the tariff for use of the national transmission system and the tariffs for use of the distribution systems, approve the rules and tariffs for access to interconnections, and arbitrate disputes between transmission or distribution system users and the operators concerned.

The legal framework of renewable energy sources integration in the national grid was introduced with renewable energy law 13-09 (2009) [48], (complemented in Decree 2-10-578 [49]) which governs the generation of power from renewable sources. It establishes a legal framework that allows individuals or legal entities, public or private, to construct and manage facilities for the generation of electrical energy from renewable energy sources with a capacity between 2kW and



2MW with authorization for any projects above the stated maximum capacity. It describes the broad principles that they must follow, the law only allows excess energy injection into the grid in MV (medium voltage) or HV (High Voltage) and VHV (Very High Voltage). An update of the law was introduced in 2015 with law 58-15 [50] addressing the integration of the injection of energy excess to the ONEE (Office National de l'Électricité et de l'Eau Potable one.org.ma) national grid with the limit of 20% of the annual RE energy generation. As well as the opening of a medium-voltage network to electricity producers that use renewable energy sources, allowing for the development of a local industrial sector of small and medium-sized businesses. The grid access was detailed in a complementary Decree 2-15-722 [51] stating conditions and rules for grid network connection for the medium voltage which has not yet been fully implemented.

5.6.2 Recent Developments

In 2021, Decree 3851.21 presented legislation mandates for distribution companies, which can be either private or public, to set the so-called "RE envelopes," or the amount of RE generation that can be integrated in the low and medium voltage networks in each distribution zone from 2022 to 2031 (between 5% and 10% of total generation in each zone). As part of the legislation of RE production, Decree 2138.22 introduced in September 2022 specifies the areas designated to receive development sites for solar electric power generation projects designated for medium voltage interconnection (2.2kV-5kV). Since the distribution grid has not been opened and the regulations for access, connection, tariffication, and grid profile are still unclear, there are still challenges in the development of distributed generation in Morocco. Furthermore, the specific energy curtailment of PV-generating sources has not been extensively examined² [52].

5.6.3 Self-Consumption

The ambitious plan of renewable energy integration in the energy eco-system has been reinforced with the introduction of self-production, which has been recently introduced in the draft legislation n°82-21 published in 2021 [53] and is in the final stages of implementation at the time of writing, allowing the RE production of small capacities and injection in the LV network (Low voltage) while allowing a maximum of 10% annual energy surplus. The purpose of the draft law is to establish a complete legal regime for self-production in Moroccan legislation. This concept is notably absent from the major law on renewable energies (law n°13-09) . This proposed legislation establishes three levels for regulating self-generation when coupled to the ONEE national electrical networks, declaration system, connection approval system, and authorisation system depending on the capacity of the self-generation source and network voltage level.

5.7 Spain

In Spain the PV systems, up from 0,5 MW or in clusters of more than 0,5 MW, are connected to a control centre. The communications between the control centre and the PV systems have been regularly tested and certified by the system operator. In this case, the system operator communicates curtailment orders to the control centre and the later execute these orders. These processes are described in the national grid codes

² See also: http://www.sgg.gov.ma/BO/AR/3111/2022/BO_7129_Ar.pdf



5.8 Spain – Canary Islands

PV and wind capacity placed in the six power systems of the Canary Islands is growing substantially, and it is expected to match the conventional capacity in a few years (Table 3).

Table 3: Capacity mix in Canary Islands (2022)

	2022	New capacity with access to the grid approved
Conventional	2103 MW	
Wind	573 MW	511 MW
PV	205 MW	1.091 MW
Other renewables	17 MW	
Self-consumption (mostly distributed PV)	80 MW	0,18 MW/day connected

In consequence, PV and wind energy injected to the grid is periodically limited by the system operator (SO). This is due to the fact that the electric grid of the Canary Islands is composed by 6 small insular power systems currently managing more than 20% of the electricity from wind and PV (2022), and without any storage capability for the integration of the renewable electricity (except in the case of the small island of El Hierro). Nevertheless, the largest instantaneous penetration of renewable electricity in the Canaries has been a 65,71% in the insular power system of Tenerife (14/04/2022), and the maximum daily penetration has also been reached in Tenerife (51,58%, on 06/12/2021).

In parallel to the increase of PV and wind generation in the Canaries, curtailment has also increased substantially in recent years (Figure 22). Accurate measurements of the curtailed values are still in progress due to the lack of a dynamic and validated signal from some of the PV and wind renewable plants (96,1% of the PV and wind capacity is monitored, but only 41% of the signals can be validated). However, initial studies of the SO show how curtailment is affecting the production of wind and PV energy in the different power systems (Figure 23).

Subsistema	% Tiempo limitado			
	2019	2020	2021	2022
Tenerife	0,16%	1,79%	6,64%	9,8%
Gran Canaria	1,58%	6,56%	6,36%	15,9%
Lanzarote – Fuerteventura	0%	1,65%	18,48%	25,7%
La Palma	0%	0%	0,29%	6,8%

Figure 22: Percent of time power generation from wind and PV has been limited in 2022 [45]



Subsistema	enero	febrero	marzo	abril	mayo	junio	julio	agosto	septiembre	octubre	noviembre	diciembre	Total acumul...
Gran Canaria	3,62%	1,59%	3,37%	4,93%	2,74%	3,61%	2,09%	4,13%	2,67%	3,87%	3,80%	0,35%	3,25%
Tenerife	5,26%	3,53%	1,14%	4,18%	3,05%	1,52%	1,19%	2,46%	1,32%	0,58%	2,16%	0,79%	2,28%
Lanzarote-Fuerteventura	4,35%	7,28%	6,66%	1,26%	6,77%	12,54%	7,31%	5,48%	6,50%	7,67%	6,07%	7,12%	6,90%
La Palma	0,03%	1,44%	0,56%	1,75%	6,07%	3,18%	0,75%	1,43%	3,52%	3,07%	1,13%	2,55%	2,12%
Total	4,50%	3,21%	2,90%	4,22%	3,36%	4,07%	2,47%	3,72%	2,77%	3,14%	3,35%	2,01%	3,34%

Figure 23: Estimation of electricity curtailed in the different insular power systems of Canary Islands in 2022 [45]

Because of the specific nature of these insular power systems and the increasing share of renewable electricity in the Canary power systems, the government of Spain has enforced specific grid codes for regulating curtailment, the most important grid code is the PO SENP 1 (Funcionamiento de los sistemas eléctricos no peninsulares) approved on December 2019. This grid code establishes the frequency limits of these insular power systems:

- 49,85 – 50,15 Hz; and 49,75 – 50,25 Hz in less than 5 min intervals.

Table 4: Voltage limits

Level	Minimum (kV)	Maximum
220 kV	110 kV (95%)	245 kV (111%)
132 kV	125 kV (95%)	145 kV (110%)
66 kV	62 kV (94%)	72 kV (109%)

and the capacity limits of the transformers (110 – 125%) and power lines (< 115%), depending on time period ($t < 20$ min; $20 \text{ min} < t < 8$ h) and the season (summer, winter, spring and autumn).

In addition, the PO SENP 1 defines the reserves for each regulatory reserve and hourly period:

- Primary regulatory reserve (up to 30 secs): 50% of the highest capacity assigned to a power unit in that hourly period.
- Primary + Secondary regulatory reserves (up to 15 min): the highest of the following values:
 - 100% of the highest capacity assigned to a power unit in that hourly period.
 - Growth in demand between the hourly period and the following hourly period.
 - The capacity of the interconnections in that hourly period.
 - The maximum probabilistic loss of renewable generation in that hourly period.

In addition, the secondary reserve to ramp-down must be, at least, a 50% of the secondary reserve to ramp-up.

- Tertiary regulatory reserve (from 15 min): the same reserve as for primary + secondary regulatory reserves.

Based on the grid code PO SENP 1, the grid code PO SENP 3.7 (Programación de las instalaciones de producción de categoría B) regulates how the system operator (OS) programmes the maximum power generated by wind and PV plants with unit nameplate capacity above 0,5 MW. The limits are defined hourly, per node and technology. The maxima capacities are shared between nodes in proportion to their programmed hourly power to be served. The control of these



wind and PV plants is placed in a control centre in communication with the SO. This enables the SO to communicate the power limits per node and technology, and internally the control centre shares the limits between the renewable power units. The power units must readjust the power limits in 5 – 15 minutes.

If congestion is produced more than 3 times in a month or 10 times in a year, the SO must submit in less than 6 months a document explaining how to solve it.

However, it is still not transparent how the curtailment needs are established in each hourly period and how the power limits are shared between control centres.

5.9 Switzerland

According to the Swiss Energy Act [54], grid operators must purchase and remunerate electricity from renewable sources. There is no legal basis for the DSO to curtail PV systems.

However, the Swiss DSO association “Verband Schweizerischer Netzbetreiber VSE” publishes the recommendations for network operators “NA/EEA-2020” [55]. In this document, VSE recommends to use similar generation control mechanisms for PV systems connected to Swiss DSO’s as it was requested in Germany. Also, a P(U) regulation gradually curtailing PV systems if voltage rises above 110% of the nominal voltage is proposed in these recommendations. These control schemes are not foreseen for normal operation, but only for emergency control.

5.10 USA

5.10.1 Current Practices of Distributed Energy Resources Active Power Management

As PV penetration increases, active power management of DER becomes necessary in order to ensure grid reliability. The main reasons to manage DER active power are serve load variability, optimize energy use, increase grid hosting capacity, and export maximum energy without exceeding grid power limits. The incentives to manage power can be found at all levels in the electric grid including local, feeder level, and balancing area.

In the USA we experience utilities managing DER active power with notably different penetration levels of DER. These range from inverter performance requirements to time varying schedules and real time communications. There are three mutually exclusive management forms around the broader concept of DER integration and grid flexibility.

1. **Response to Abnormal Grid** – includes built-in DER response to grid voltage and frequency as well as utility operated plant level switching. These are contingencies, the grid is flexible about export until it is abnormal, then it is not.
2. **Firm Capacity Limits** – flexibility in time, a time-varying schedule in an important option. This is also a real power management solution without communication.
3. **Signalled Capacity Limits** – time varying flexibility can be either with penalties or with incentives, it implies markets, economic dispatch, and the concept of DERMS.

Management locations range from the DER plant, the distributor and up to the electricity market level. Use cases are shown in Figure 4



We find a wide variety and characteristics in real power management approaches and their use. Clearly power delivery and grid operator practices are evolving to maintain reliability in areas where DER deployment is significant. Active power management from any level can provide support grid integration of DER. The following is a summary of applications by grid level:

1. At the DER level (via Trip, Volt-Watt or Frequency-Watt Functions)
2. At the PCC level (employing DER generation, storage, and load)
 - Fixed Export Limiting
 - Scheduled/Flexible Export Limiting
3. At the Feeder level – (via decentralized DERMS or remote-control using SCADA)
4. At the Substation level – (employing centralized DERMS)
5. At the Bulk level – (via System Operator and automatic generation control AGC)
6. At the market level – (via market rules, service options and economic signals)

Key points in the current learning are the many options and potential advantages of managing active power compared to electric grid upgrades. Real power management enables DER deployment beyond existing grid capacity. Application of real power management is a critical step toward future DER support of the distribution and bulk electric power systems.

5.10.2 PV Curtailment Statistics

In a study [56], NREL has investigated the state of the art of curtailment in key markets. It was found, that curtailment correlates to the level of PV penetration, but not only. Depending on the local situation, the amount of curtailed energy varies a lot between the investigated grids (Table 5).



Table 5: PV Curtailment Statistics in Key PV Markets from [56]

Location	Installed Curtailable PV Capacity (MW)	Curtailed PV Output in 2018 (MWh) ^b	% of Potential PV Output that is Curtailed	Curtailment Drivers
<i>United States</i>				
California	13,500 ^a	432,000	1.5%	System-wide oversupply
Texas	2,400 ^a	270,000	8.4%	Oversupply due to clustering of PV projects
Arizona	2,000 ^a	17,100	2.9%	Negative pricing in regional market
Hawaii	140	4,100	2.7%	Oversupply
<i>Other Countries</i>				
Chile	2,340 ^b	150,000*	6%*	Regional transmission constraints
China	123,840 ^c	5,490,000	3.8%	Regional transmission constraints
Germany	46,000 ^d	116,470	0.3%	Grid congestion

^a [19]; ^b [20]; ^c [21]; ^d [22] ^e Data sources are defined in each sub-section; * Based on 2016 estimated PV output from the International Renewable Energy Agency [23], estimate of 6% curtailment of all renewables—including wind [24].

5.10.3 IEEE

In the USA, some IEEE standards are widely used and constantly modified for the DER integration, the data model, communication structure and test procedures defined by those standards provide the PV industry with a solid basis for the PV curtailment.

5.10.3.1 IEEE 1547 Standard for Interconnection and Interoperability of Distributed Energy Resources with Associated Electric Power Systems Interfaces

The function and position of the American IEEE 1547 is similar to the EN 50549-1 and -2 in Europe or the AR-N 4105 in Germany. Although the scope and the required functions are partly almost identical, different conventions are used and no harmonisation between the documents is in place.

5.10.3.2 IEEE 1547.1 Standard Conformance Test Procedures for Equipment Interconnecting Distributed Energy Resources with Electric Power Systems and Associated Interfaces

The 1547.1 specifies the test procedures of the functionalities required in IEEE 1547. It is technology independent and covers basically the same functions as the European EN 50549-10.

5.10.3.3 IEEE Communication Documents

DNP3 (Distributed Network Protocol version 3.3), which is specified in IEEE 1815-2012 [57], is an open standard for telecommunication designed for interaction between master stations, RTUs and other Intelligent Electronic Devices (IEDs) in electrical utilities and industrial environments. It was



designed for SCADA systems to transmit considerably small data packets. DNP3 is typically deployed on serial communication (RS-232 and RS-485) over various physical links, such as twisted pair, optic fibre, radio and satellite communication. DNP3 is more robust, efficient, and interoperable than Modbus, at the cost of higher complexity [32]. For instance, another standard document IEEE 1815.1-2015, the IEEE Standard for Exchanging Information Between Networks Implementing IEC 61850 and IEEE Std 1815(TM), specifies the standard approach for mapping between IEEE Std 1815™ (DNP3) and IEC 61850 [58].

The IEEE 2030.5 Smart Energy Profile 2 (SEP2.0) has been extended using IEC 61850-7-420 logical node classes for DER components to meet DER integration requirements for CA Rule 21 [59].

At the fieldbus level, the SunSpec Alliance has designed the SunSpec Public Key Infrastructure (PKI) and extended the SunSpec Modbus specification with the 700 series along with the DER information model to enhance the DER access for stakeholders including DSOs. To include standardized interoperability functionality, the IEEE 1547 standard was updated in 2018 with a specification for technical requirements relevant to the performance, operation, testing, safety considerations and maintenance of the interconnection of DER in electrical grids, which also addresses the topic “Limit active power” [60]. In terms of physical interconnection requirements and test procedures for DER, the work in [61] delivers an overview of the evaluation of DER interoperability to IEEE 1547.1 for SunSpec Modbus DER, IEEE 1815 and IEEE 2030.5.



6 EXAMPLES, IMPLEMENTATIONS, PROJECTS

6.1 Austria

In Austria, the P(U) function for low-voltage connected generating systems was first introduced by some DSOs in the mid-2010s and has become a common requirement for all new low-voltage connected generating systems with the revision of the nationwide rules in 2020.

Today, the P(U) function with an activation threshold at 110% U_n (upper limit of the grid voltage according to EN 50160) is activated as per default with selecting the appropriate country setup of the PV inverters. Generally, given the activation threshold of 110% U_n , it must be noted that the P(U) in Austria is not intended to increase the hosting capacity of the networks and as such, it is usually not considered during the grid interconnection assessment process. The clear aim is to avoid unwanted disconnection of the distributed generation, especially during situations where the distribution grid is operated in abnormal switching configurations or is unexpectedly weakened by other circumstances.

Since 2020, also the Austrian national testing specification for generating systems (OVE R25) includes a procedure for the qualification testing of the static as well as the dynamic response of the P(U) control, integrated in the inverters. All PV inverters which are to be installed in Austria have to be tested accordingly.

An informal survey among Austrian DSOs yielded commonly positive feedback after the first years of implementation, with very few complaints about malfunctions, stability problems or other issues. The main aim of the P(U) control function, namely, to avoid unwanted disconnection of the PV systems due to overvoltage protection has been widely achieved. In Austria, the first stage of the over-voltage protection triggers the disconnection, if the 10-minutes average of the grid voltage exceeds a value of 111% U_n .

However, the field experiences reported by Austrian DSOs highlight critical details, which have to be considered for the effective implementation of the P(U) grid support function in practise:

- It is important to exactly specify the voltage to be used as a reference for the P(U) control. The current definitions, e.g., in Austria however do not provide a clear definition which leads to different interpretations and inconsistent behaviour of the inverters.
- To achieve the goal, namely, to avoid the disconnection due to over-voltage protection tripping, the clear recommendation is to preferably use the maximum of the three line-to-neutral voltages, as the voltages inside low-voltage customer installations are often significantly unbalanced. Using the average of the line-to-neutral voltages may lead to situations, where a single-phase over-voltage may inadvertently trigger the over-voltage protection before the P(U) function is activated.
- Inverters which are capable to provide phase-independent control of their output power shall be allowed to use this capability to limit their output power individually according to the phase-to-neutral voltages.
- To avoid triggering oscillations it is important that the P(U) function is implemented with a defined dynamic response and does not cause any step-changes of the output power of the generator. In Austria, a response equal to a first-order filter with a time constant of 5 s and a time delay as short as possible is required as per default. So far, no issues related to the voltage stability were reported with these settings.



- To achieve the consistent operation of all distributed generation in a grid, it is important that the P(U) function is implemented with a high level of accuracy. In particular the accuracy of the voltage measurement is critical, as it largely defines the actual P(U) response.

Based on the positive experiences, several DSOs are today investigating options to adapt their interconnection practises, in particular the assessment procedures, to allow the operation of the distributed generators “closer” to the upper grid voltage window, actively utilizing the P(U) function to avoid over-voltage disconnections and thus increase the hosting capacity.

For any of these strategies to be successful, it is important that the DSOs as well as plant operators may “trust” in the accurate and reliable operation and in particular the correct parameter settings of the inverters.

On the regulatory and legal level, Austrian stakeholders, including the Austrian PV community are currently discussing different regulatory options to utilize the P(U) to increase hosting capacity for new generating systems

6.2 Germany

Research projects related to PV power management :

- **CLS-App-BW** (2016-2018): Utilisation of standardised data model and communication protocol for DER-grid communication, especially direct PV curtailment. This project proved that utilisation of CLS control boxes is suitable for the operation of smart grids, based on international standards. Existing components of the prosumer are integrated into the network in order to achieve improved feed-in management, adaptation and control of system services and secure market integration.
- **Grid-Predict** (2015-2018): Coordination of PV and battery system and development of methods to correctly determine the grid condition even at high levels of fluctuating feed-in at the low-voltage level. This project successfully demonstrated the monitoring and control of PV and battery system using standard protocol IEC 61850 and tele-communication routes to the SCADA system; a computation-optimized probabilistic load flow method was developed to achieve predictive grid calculation.
- **SINTEG-C/sells** (2017-2021): Demonstration of the Smart-Meter-Infrastructure, cellular grid organisation concept, secured DER control with CLS-gateways and market interface for flexibility. Setup of a complex Smart-Meter-Infrastructure including CLS-management system; concept for the system integration of smart grid components; Development of a partial-automated framework for the deployment of Smart-Meter-components; simulation framework for DSO-TSO coordination and real-time simulation of distribution grids; secured DER remote control with IEC 61850 through the encrypted channel established by SMGW; Integration of consumer and prosumer energy system in DSO SCADA.
- **Smart beats Copper, EU ERIGRID** (2017-2018): Tele-communication and control of PV inverter in distribution grid SCADA; Power-Hardware-in-the-Loop simulation of PV inverter control. A network simulation configuration combining the concepts of hardware and software in the loop (HIL-SIL) has been developed and validated for laboratory applications. The real-time control of a PV inverter by the logics in the SCADA system has been demonstrated.
- **SYS/DL2.0** (2014-2018): Developing and validating the system-based principles for the coordinated provision of ancillary-service upstream products; Infrastructure for the standardized data exchange. A platform was developed to enable distribution grid operators to provide the reactive power required for the stable and secure operation of electrical grids by coordinating the control of decentralized generation plants. In addition to



control and optimisation modules, the platform also includes the necessary components for standardized communication between distribution grid operators and transmission grid operators.

- **Spin-AI** (2019-2022): The aim of the SpiN-AI project is the development and testing of innovative and practical procedures and (software) modules for peak capping in grid planning, as well as the investigation and evaluation of the expected effects on the need for grid expansion. On the one hand, an integrated HV/ MV planning of the distribution system and, on the other hand, a separate planning of the HV and MV in the hands of two DSOs are considered.
- **PV-Regel** (2020-2022): Potential of using decentralized PV systems to provide system balancing power. Utilisation of Smart-Meter-Infrastructure and standardized IEC 61850 data model; Deployment of communication protocol such as MQTT with higher reliability to achieve better system performance.
- **Connect+** (Implementation project of the Redispatch 2.0 Scheme by BDEW): Connect+ aims to ensure data exchange for the implementation of Redispatch 2.0 in accordance with the legal requirements of the NABEG. Specifications for DSO; setup of unified IT-platform; new concept, use cases and working process to bind PV-systems to the Redispatch 2.0 schema in Germany.
- **FNN Hinweise (VDE FNN documents)**: VDE FNN defines the minimum requirements for technology and operation of power networks in application rules, and provides technical guidance for grid operators, plant operators, manufacturers and other professionals working on the power grid. These documents support with the onboarding and classification of innovative grid technologies³.

6.3 Japan

6.3.1 NEDO R&D Project on Grid Integration of Variable Renewable Energy: Mitigation Technologies on Output Fluctuations of Renewable Energy Generations in Power Grid Enhanced renewable energy connection with power grid

Aiming to establish a fair and feasible remote output control method through demonstration tests and to develop a remote output control system that power generation companies were requested to install based upon requirements by each TSO, in compliance with the revision of the FIT Act in 2015, a NEDO project was carried out from 2016 to 2019,

To grasp the power output of the PV power generation facilities distributed in the area and issue output control commands at the central load dispatching office, etc., equipment for them and a management system of power generation output were established.

In addition, PCSs with output control functions were installed at power generation companies connected to the power system, and the effectiveness of both two-way and one-way communication methods was verified in the project. The technical specifications were established by this project for active power control (curtailment) described in the previous chapter.

³ See also <https://www.vde.com/en/fnn/dokumente-en>



Demonstration partners' sites (as of February 2018)

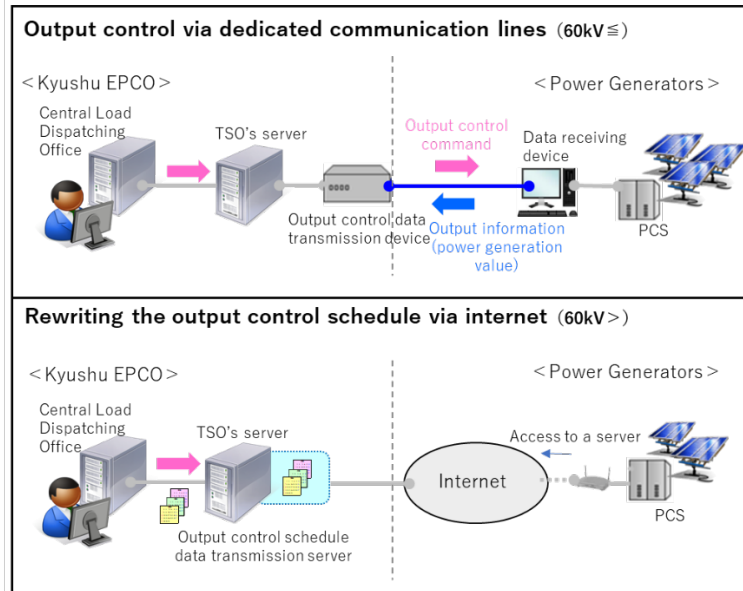
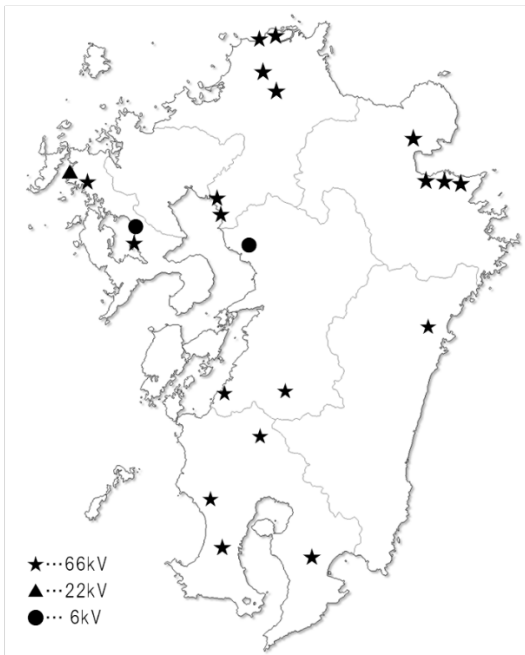

Figure 24: Configuration of the demonstration in Kyushu area

6.3.2 NEDO Development of next-generation power network stabilization technology for large-scale introduction of renewable energy - Development of control system for realizing “Japanese Connect and Manage” scheme.

To make the most of the existing grid against the congestion due to the increase of renewables, a NEDO project has been being carried out from 2019 to 2023, with the view to developing a system for non-firm connection, which is one of the " Japanese Connect and Manage".

A feasibility study was conducted in 2019, and from 2020 onwards, NEDO has been focusing on the following.

- Development of “Japanese Connect & Management System”
- Survey and analysis of forecasting errors using existing technologies for forecasting renewables and demand for each transmission system
- Evaluation and examination of risk and security measures when operating the system to be developed
- Demonstration in an actual grid using the system to be developed

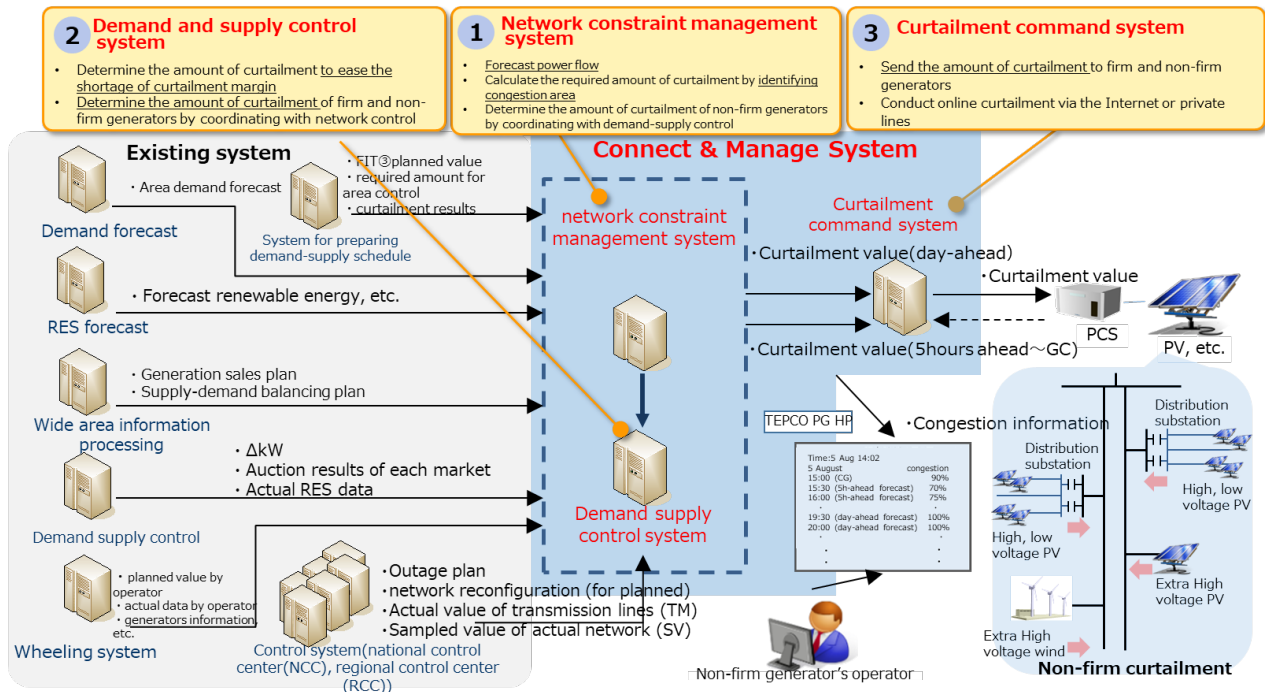

Figure 25: Japanese Connect and Manage system

6.3.3 NEDO Development of Flexible and Distributed Energy Resources Control Technology to Mitigate Congestion in Power Systems (FLEX DER) project

In the near future, in order to mitigate congestion in the power system and expand the introduction of renewables, especially PVs in Japan, it is expected to actively control distributed energy resources (DERs) connected beyond distribution substations. Therefore, NEDO has started a project planned from 2022 to 2026 to develop technologies for building a DER flexibility system including a platform that connects aggregators and DERs developers with TSOs, grasps the congestion status of the grid and the operation status of DER in the distribution network, and enables DER control.

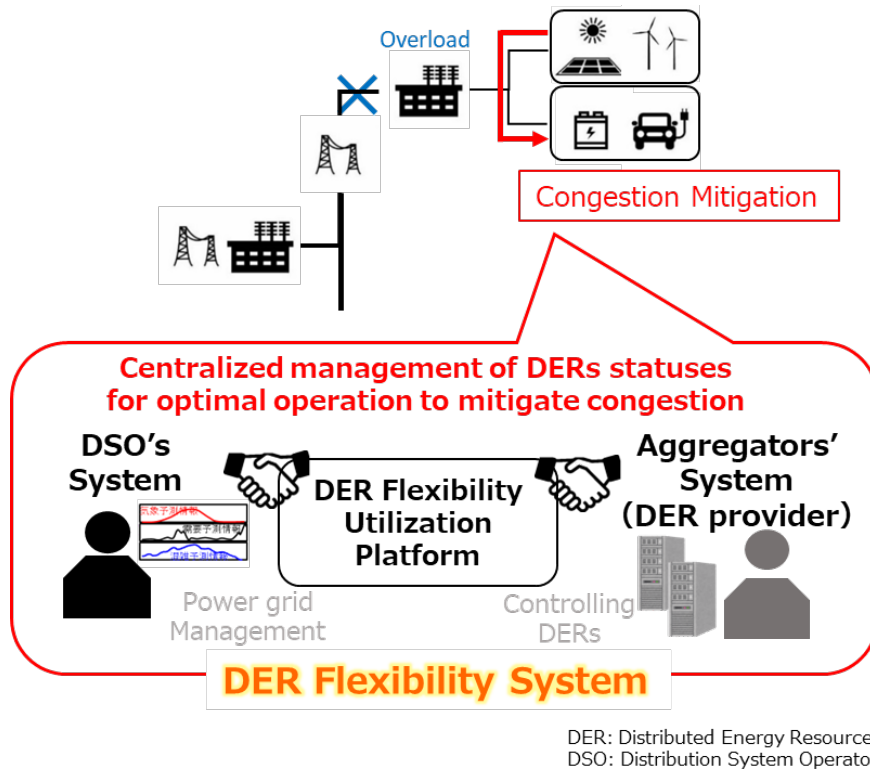

Figure 26: Image of development target in the FLEX DER project⁴

6.4 Switzerland

As part of the "Grid Optimisation with Decentralised Actors" (GODA) project, the grid operator Groupe E tested the use of P(U) in the distribution grid in a field trial, while the Bern University of Applied Sciences (BFH) analysed the control methods of inverters individually and in groups at the same grid connection point with measurements in the laboratory [63].

P(U) was successfully adjusted and tested on PV systems in the field. The inverters show the desired reduction in active power when the grid voltage is too high. Using self-learning algorithms that evaluate the production data from the smart meters, the production losses can be calculated and the producers compensated. The measurements in the laboratory show a stable behaviour of the inverters with reasonable typical settings of the control parameters - both individually and in groups, although the control behaviour among the devices shows great differences.

Take home messages of the projects are:

- Commercially available inverters are prepared for P(U). They can usually be parameterised intuitively by the installers and regulate the active power as expected with sensibly selected settings.

⁴ Synchronous grids are operated by 10 TSOs in Japan. TSO and DSO are integrated per a balancing area.



- The production losses can be calculated with self-learning algorithms and compensated to the producers at the feed-in tariff. The expenses are covered as chargeable measures from the grid utilisation costs.
- The reliability and stability of the voltage-dependent active power control of 3 string inverters could be observed in the laboratory. However, the devices show considerable differences in control behaviour and accuracy.
- The activation of P(U) in inverters in grid areas with emerging voltage maintenance problems and the use of the presented compensation approach represents a fast-acting, intelligent and pragmatic alternative for grid reinforcement.
- The regulatory framework conditions for the nationwide use of P(U) are currently not yet in place (Switzerland). The authors of this study recommend that the responsible authorities create the appropriate framework conditions.

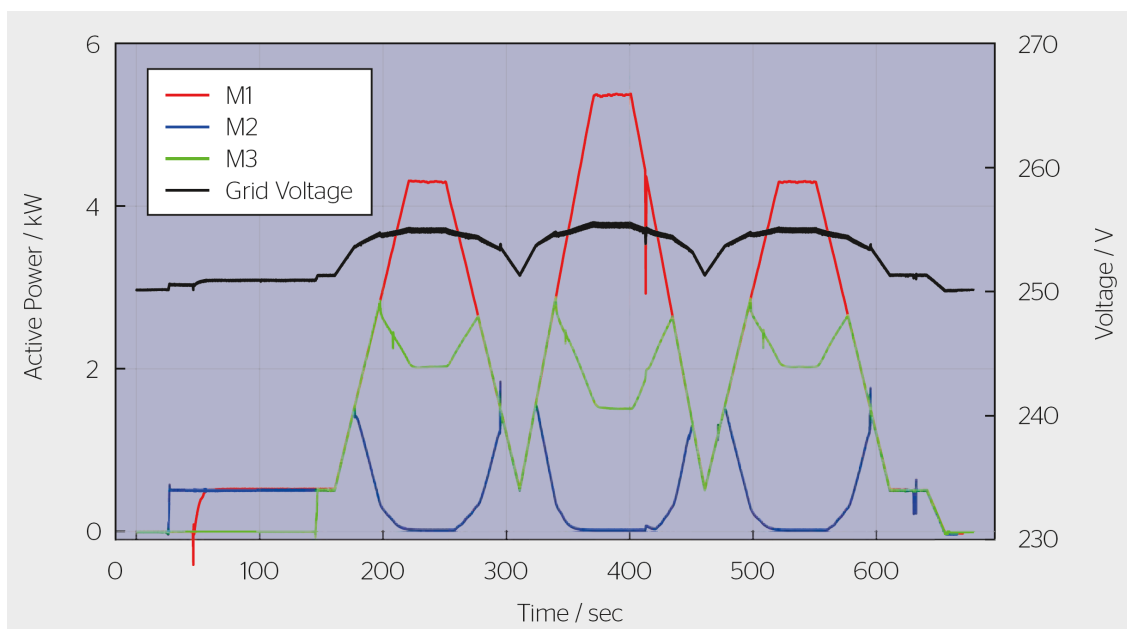

Figure 27: Laboratory tests of the P(U) function showing significant differences between the behaviour of three inverters with identical settings [63]



7 RECOMMENDATIONS

Active power management (APC) and thus power curtailment of PV systems is a powerful method to integrate more PV into the grid.

APC is used successfully in many different ways around the world. The use of APC initially leads to very low energy yield losses. When APC is used to reduce the PV power a lot, yield losses can increase. In these cases, methods for APC that reduce yield losses should be chosen.

In order to get the most out of APC and to keep curtailment losses as low as possible, the following recommendations are made:

- Apart from very small and simple APC measures such as choosing a low sizing ratio (SR), APC should never be the only method for grid integration of solar power. Other measures such as demand side management, self-consumption optimisation, reactive power control or possibly installation of storage systems should at least be examined.
- However, APC should be considered from the system perspective right from the start. The electricity grid should not be dimensioned for the full DC power of the PV systems, but - depending on the overall strategy - only for approx. 25 % - 75 % of the DC power. In individual cases, the value can be even lower.
- With APC, there is a great potential added value of PV systems. In power-controlled operation, one is no longer at the mercy of the sun, but can react dynamically and symmetrically to load and grid requirements. This makes solar electricity more valuable.
- APC should not be defined at the PV system, but at the grid connection point, for example, especially for mixed/hybrid prosumer systems. If the grid area is sufficiently defined, APC can also be extended over the entire grid area.
- Grid expansion should be thought of in the context of an overall strategy. It is not expedient to expand a distribution grid for photovoltaics if the overall system cannot absorb the power and energy surpluses anyway. In this case, local solutions should be implemented, secured with the curtailment of the PV systems.



APPENDIX A: SPECIAL SITUATION OF JAPAN

Rapid renewable energy deployment

Japan has been experiencing a rapid deployment of PV since the FIT act for renewable energy sources (hereafter referred to as “renewables”) was launched in July 2012. As shown in Figure 28 and Table 6, which were sourced from the Agency for Natural Resources and Energy, the Ministry of Economy, Trade, and Industry (METI), the current PV generation is nearly 8% of Japan’s power generation mix and the current PV deployment capacity is nearly 64GW, that are more than double compared to before the launch of FIT. Moreover, in October 2021, the 6th Strategic Energy Plan was decided in anticipation of carbon neutrality in 2050, and the new PV targets were set at 36-38% and 103.5-117.6 GW respectively, meaning that more than double the PV will be installed by 2030FY. In Japan, a large amount of PVs is expected to be connected not only to distribution systems (under 6.6 kV) but also to transmission systems (more than 66 kV).

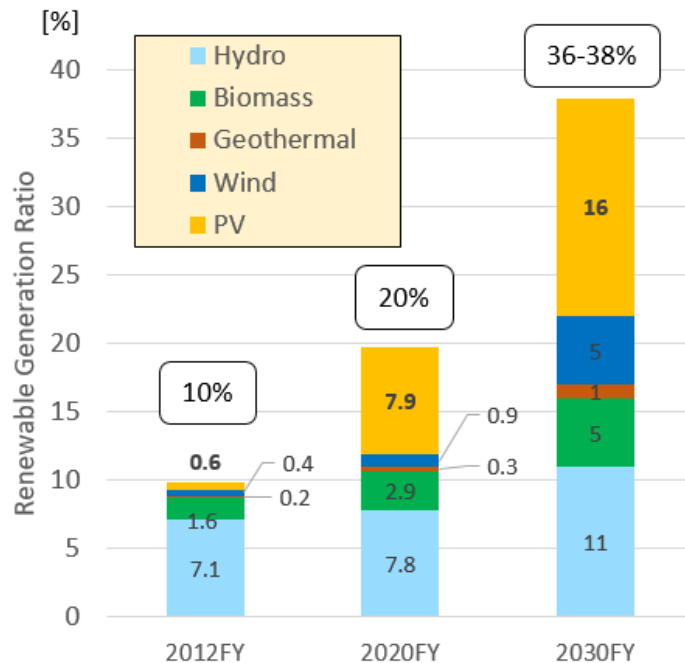

Figure 28: Renewable generation deployment in Japan (Source: Agency for Natural Resources and Energy, METI)



Table 6: The progress toward renewables deployment capacity before and after FIT, as of Fiscal Year 2020

	Before FIT (June 2012)	After FIT (A) (FY2020)	Target (B) (FY2030)	Progress (A)/(B)
PV	5.6 GW	63.8 GW	103.5~ 117.6 GW	58%
Wind	2.6 GW	4.6 GW	23.6 GW	19%
Geothermal	0.5 GW	0.7 GW	1.5 GW	41%
Hydro (Middle and small)	9.6 GW	9.8 GW	10.4 GW	94%
Biomass	2.3 GW	5.3 GW	8.0 GW	66%

The increasing penetration levels of variable renewables, especially PVs, have been affecting power system operations in each of Japan's 10 balancing areas. Especially, the power system in Kyushu, the southernmost of the four main islands of Japan has been the most severely affected by the rapid and heavy PV generation penetration. By the end of December 2022, the PV capacity had reached 11.44GW: 2.15GW is from less than 10kW systems, 9.29GW is from more than 10kW systems, which is by ten times in only 10 years after the launch of FIT in 2012 and significantly exceeded the minimum daytime load.

To accommodate the rapid growth in variable renewables, the government established the working group on grid connection of renewables in 2014 to continually discuss and make timely decisions about these operational issues including inevitable curtailment procedures for renewables. Then online curtailment was positioned as one of key measures for the efficiency and security of renewables restriction procedures, the reduction of the required amount of renewable generation limitation, and the security of the power supply.

Figure 29 depicts interconnected balancing areas and their maximum demand.

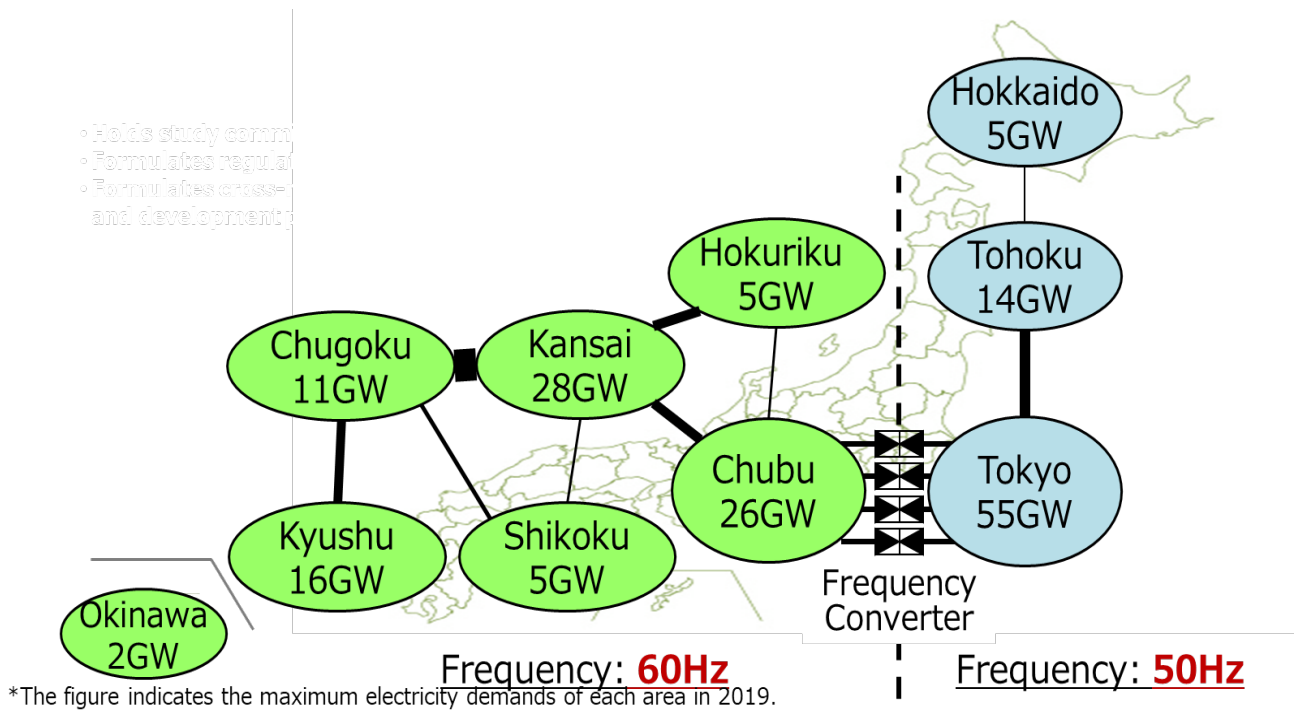

Figure 29: Interconnected balancing areas in Japan



8 REFERENCES

- [1] C. Bucher and D. Joss, “Grid connection of 50 gigawatts photovoltaic systems in Switzerland: Discussion paper on solutions for the grid integration of solar power,” Laboratory for Photovoltaic Systems, Burgdorf, 2023. Accessed: Oct. 13 2023. [Online]. Available: <https://arbor.bfh.ch/id/eprint/19728>
- [2] R. Perez *et al.*, “Firm power generation,” *IEA-PVPS*, 2023. [Online]. Available: <https://iea-pvps.org/key-topics/firm-power-generation/>
- [3] O. Gandhi, C. D. Rodríguez-Gallegos, W. Zhang, T. Reindl, and D. Srinivasan, “Levelised cost of PV integration for distribution networks,” *Renewable and Sustainable Energy Reviews*, vol. 169, p. 112922, 2022, doi: 10.1016/j.rser.2022.112922.
- [4] Y. Yasuda *et al.*, “Flexibility chart 2.0: An accessible visual tool to evaluate flexibility resources in power systems,” *Renewable and Sustainable Energy Reviews*, vol. 174, p. 113116, 2023, doi: 10.1016/j.rser.2022.113116.
- [5] P. Cuony, “Akzeptanz von Smart-Grid-Technologien,” *Bulletin VSE/electrosuisse*, 2022. [Online]. Available: <https://www.bulletin.ch/de/news-detail/akzeptanz-von-smart-grid-technologien.html>
- [6] M. Yamazaki, “National Survey Report of PV Power Applications in JAPAN,” *Photovoltaic Power System Programme*, vol. 2021. [Online]. Available: https://iea-pvps.org/wp-content/uploads/2022/11/NSR_Japan_2021.pdf
- [7] D. Nousios and S. Aebi, “Principles of ancillary services products,” 2022. [Online]. Available: <https://www.swissgrid.ch/dam/swissgrid/customers/topics/ancillary-services/as-documents/D220824-AS-Products-V19-en.pdf>
- [8] Solargis, *Global Solar Atlas*. [Online]. Available: <https://globalsolaratlas.info/map?c=32.138409,-58.007813,4> (accessed: May 26 2023).
- [9] *Solar resource maps of World*. [Online]. Available: <https://solargis.com/maps-and-gis-data/download/world> (accessed: May 26 2023).
- [10] AAPowerLink, *AAPowerLink | Large Scale Renewable Energy - AAPowerLink*. [Online]. Available: <https://aapowerlink.sg/> (accessed: May 26 2023).
- [11] Sun Cable, *Sun Cable | The World’s Largest Solar Energy Infrastructure Project*. [Online]. Available: <https://suncable.energy/> (accessed: May 26 2023).
- [12] Thomas Key, Brian Seal, Aminul Huque, “DER Active Power Management,” *22nd Wind & Solar Integration Workshop | Copenhagen, Denmark | 26 – 28 September 2023*, vol. 2023, 2023.
- [13] C. Bucher, J. Wandel, and D. Joss, “Life Expectancy of PV Inverters and Optimizers in Residential PV Systems,” 2022.
- [14] B. Jäger and P. Langenstein, “Dynamische Wirkleistungsreduktion (Active Power Curtailment APC) – Photovoltaik,” Bachelorarbeit, Hochschule Luzern.
- [15] *Requirements for Generators*, 2016. [Online]. Available: https://www.entsoe.eu/network_codes/rfg/
- [16] Technical Information, “PV Inverters: Use and Settings of PV Inverters in Off-Grid Systems,” [Online]. Available: <https://www.sma-sunny.com/wp-content/uploads/2016/12/SB-OffGrid-TI-en-42.pdf>
- [17] *Gesetz für den Ausbau erneuerbarer Energien, § 9 Technische Vorgaben: Erneuerbare-Energien-Gesetz - EEG 2023*, 2023. Accessed: Oct. 13 2023.
- [18] S. Ishaq, I. Khan, S. Rahman, T. Hussain, A. Iqbal, and R. M. Elavarasan, “A review on recent developments in control and optimization of micro grids,” *Energy Reports*, vol. 8, pp. 4085–4103, 2022, doi: 10.1016/j.egy.2022.01.080.
- [19] T.-L. Nguyen, Y. Wang, Q.-T. Tran, R. Caire, Y. Xu, and C. Gavriluta, “A Distributed Hierarchical Control Framework in Islanded Microgrids and Its Agent-Based Design for Cyber–



- Physical Implementations,” *IEEE Trans. Ind. Electron.*, vol. 68, no. 10, pp. 9685–9695, 2021, doi: 10.1109/TIE.2020.3026267.
- [20] *Weshalb stehen Windenergieanlagen still?* [Online]. Available: <https://blog.vdi.de/weshalb-stehen-windenergieanlagen-still> (accessed: May 26 2023).
- [21] *Gesetz für den Ausbau erneuerbarer Energien, (Erneuerbare-Energien-Gesetz - EEG 2023) § 9 Technische Vorgaben*, 2023. [Online]. Available: https://www.gesetze-im-internet.de/eeg_2014/_9.html
- [22] Forum Netztechnik / Netzbetrieb im VDE (FNN), *Spitzenkappung – ein neuer planerischer Freiheitsgrad: Möglichkeiten zur Berücksichtigung der Spitzenkappung bei der Netzplanung in Verteilnetzen*.
- [23] Forum Netztechnik / Netzbetrieb im VDE (FNN), *Spitzenkappung - mehr Flexibilität in der Netzplanung: VDE FNN Hinweis „Spitzenkappung – ein neuer planerischer Freiheitsgrad“ zeigt, wie Verteilnetzbetreiber das neue Netzplanungsinstrument anwenden können*.
- [24] L.-P. Lauven, J. Wiemer, F. Wenderoth, M. Vogt, M. B. Alfakhouri, and F. Schäfer, “Spitzenkappung in Netzplanung und Netzbetrieb - Automatisiert und intelligent,” Abschlussbericht, Universität Kassel, 2022.
- [25] Fraunhofer IEE, Universität Kassel, PSI, Pfalzwerke NetzAG, EnergieNetz Mitte, Avacon, *Spitzenkappung und Netzausbauplanung – Automatisiert und Intelligent (SpinAI)*.
- [26] M. Schwan, Ed., *Die Energiewende beschleunigen: ETG-Kongress 2023 : 25.-26. Mai 2023 in Kassel*. Berlin, Offenbach: VDE Verlag GMBH, 2023.
- [27] Friederike Wenderoth, Roman Bolgaryn, and Martin Braun, “A Parallel and Decoupled Approach for Time-Series-Based Planning of Distribution Grids Considering Active Power Curtailment,” *ETG Congress 2023*, vol. 2023, 2023. [Online]. Available: <https://ieeexplore.ieee.org/document/10172938>
- [28] Jan Wiemer, Friederike Wenderoth, Jan Ulfers, Alexander Scheidler, Martin Braun, “Combining Active Power Curtailment and Dynamic Line Rating in Grid Planning: An Innovative Approach,” *ETG Congress 2023, Kassel, Germany*, pp. 1–9. [Online]. Available: <https://ieeexplore.ieee.org/document/10172992>
- [29] “Benefits of advanced PV power forecasts for congestion management and reactive power management at the distribution level,” *ETG Congress 2021*, vol. 2021, 2021. [Online]. Available: <https://ieeexplore.ieee.org/document/9469522>
- [30] *Regulation (EU) 2019/943 of the European Parliament and of the Council of 5 June 2019 on the internal market for electricity*, 2019. [Online]. Available: <https://eur-lex.europa.eu/eli/reg/2019/943/oj>
- [31] C. Bucher, *Photovoltaikanlagen: Planung, Installation, Betrieb*, 1st ed. Zürich: faktor, 2021.
- [32] IEA-PVPS, “Communication and Control for High PV Penetration under Smart Grid Environment,” 2020. [Online]. Available: <https://iea-pvps.org/key-topics/communication-and-control-for-high-pv-penetration-under-smart-grid-environment/>
- [33] S. Chen, F. Ebe, J. Morris, H. Lorenz, C. Kondzialka, and G. Heilscher, “Implementation and Test of an IEC 61850-Based Automation Framework for the Automated Data Model Integration of DES (ADMID) into DSO SCADA,” *Energies*, vol. 15, no. 4, p. 1552, 2022, doi: 10.3390/en15041552.
- [34] Bundesamt für Sicherheit in der Informationstechnik, *Technische Richtlinie BSI TR-03109 - BSI TR-03109 Technische Vorgaben für intelligente Messsysteme und deren sicherer Betrieb*. [Online]. Available: <https://www.bsi.bund.de/DE/Themen/Unternehmen-und-Organisationen/Standards-und-Zertifizierung/Technische-Richtlinien/TR-nach-Thema-sortiert/tr03109/tr-03109.html;jsessionid=399DC3DC47C96D53593516B43297934A.internet462?nn=460860> (accessed: Mar. 30 2022).
- [35] “Kapitel 4. Ergänzende Rechte und Pflichten im Zusammenhang mit dem Messstellenbetrieb mit modernen Messeinrichtungen und intelligenten Messsystemen,” in *Messstellenbetriebsgesetz*, A. Steinbach and M. Weise, Eds.: De Gruyter, 2018, pp. 220–298.



- [36] *EEG 2023 - nichtamtliches Inhaltsverzeichnis*. [Online]. Available: https://www.gesetze-im-internet.de/eeg_2014/index.html (accessed: Sep. 17 2021).
- [37] *Lastenheft Steuerbox: Funktionale und konstruktive Merkmale*, 1st ed.: VDE, 2021. [Online]. Available: <https://shop.vde.com/lastenheft-steuerbox-funktionale-und-konstruktive-merkmale-13-download>
- [38] *Bundesnetzagentur - § 14a Energiewirtschaftsgesetz*. [Online]. Available: https://www.bundesnetzagentur.de/DE/Beschlusskammern/BK08/BK8_06_Netzentgelte/68_%C2%A7%2014a%20EnWG/BK8_14a%20EnWG.html (accessed: Mar. 24 2023).
- [39] Forum Netztechnik / Netzbetrieb im VDE (FNN), *Koordinierungsfunktion auf Betriebsebene KOF*. [Online]. Available: <https://www.vde.com/resource/blob/1769758/9004a095608f2226ab921769a94869f1/koordinierungsfunktion---hinweis-data.pdf>
- [40] DKE, *E VDE-AR-E 2829-6-1 (VDE -AR-E 2829-6-1):2022-07: Technischer Informationsaustausch an der Schnittstelle zur Liegenschaft und den darin befindlichen Elementen der Kundenanlagen - Teil 6-1: Use Cases*. [Online]. Available: <https://www.dke.de/de/normen-standards/dokument?id=7170551&type=dke%7Cdokument> (accessed: Oct. 13 2022).
- [41] openADR Alliance, *Purpose of Vehicle-to-Grid (V2G) Integration - and how it relates to OpenADR*. [Online]. Available: <https://www.openadr.org/openadr-v2g-and-der> (accessed: Oct. 13 2023).
- [42] K. Ogimoto and H. Wani, "Making Renewables Work: Operational Practices and Future Challenges for Renewable Energy as a Major Power Source in Japan," *IEEE Power and Energy Mag.*, vol. 18, no. 6, pp. 47–63, 2020, doi: 10.1109/MPE.2020.3014744.
- [43] METI, *METI*.
- [44] METI, *Compilation of the material 2 at the METI 4th Network Working Group*.
- [45] REE, *Comité Técnico de Seguimiento de la Operación del Sistema Eléctrico de Canarias (enero - diciembre 2021)*.
- [46] IEA, *IEA – International Energy Agency*. [Online]. Available: <https://www.iea.org/> (accessed: May 30 2023).
- [47] *Law No. 48-15 on the regulation of the electricity sector and the creation of the National Electricity Regulatory Authority*, 2016. [Online]. Available: https://www.climate-laws.org/document/law-no-48-15-on-the-regulation-of-the-electricity-sector-and-the-creation-of-the-national-electricity-regulatory-authority_252c
- [48] *N ° 13-09 Relative To Renewable Energies*, 2010. [Online]. Available: https://www.mem.gov.ma/Lists/Lst_Textes_Reglementaires/Attachments/51/13-09%20energies%20renv.pdf
- [49] *Décret n° 2-10-578 pris pour l'application de la loi n° 13-09 relative aux énergies renouvelables.*, 2011. [Online]. Available: <https://www.fao.org/faolex/results/details/en/c/LEX-FAOC106895/>
- [50] *Law No. 58-15 amending and supplementing the law No. 13-09 relating to renewable energy*, 2015. [Online]. Available: https://www.mem.gov.ma/Lists/Lst_Textes_Reglementaires/Attachments/53/loi%2058-15%20_BO6436Fr.pdf
- [51] *Decree No. 2-15-772 (October 28, 2015) on access to the national medium-voltage electricity network*, 2015. [Online]. Available: <https://faolex.fao.org/docs/pdf/mor204683.pdf>
- [52] Medias 24, *Electricité: la moyenne tension est enfin ouverte au solaire*. [Online]. Available: <https://medias24.com/2022/10/03/electricite-la-moyenne-tension-est-enfin-ouverte-au-solaire/> (accessed: Oct. 13 2023).
- [53] ". Property=", *Le Maroc prépare un avant-projet de loi concernant l'autoproduction solaire*. [Online]. Available: <https://www.pv-magazine.fr/2022/05/05/le-maroc-prepare-un-avant-projet-de-loi-concernant-lautoproduction-solaire/> (accessed: May 30 2023).
- [54] *Energiegesetz EnG, Art. 15*. [Online]. Available: <https://www.fedlex.admin.ch/eli/cc/2017/762/de>



- [55] “Netzanschluss für Energieerzeugungsanlagen an das Niederspannungsnetz (NA/EEA-NE7 – CH 2020),” 2020.
- [56] E. O’Shaughnessy, J. Cruce, and K. Xu, “Solar PV Curtailment in Changing Grid and Technological Contexts: Preprint,” 2021. [Online]. Available: <https://www.osti.gov/biblio/1823765>
- [57] *IEEE Standard for Electric Power Systems Communications-Distributed Network Protocol (DNP3)*, Piscataway, NJ, USA.
- [58] IEEE Standards Association, *IEEE SA - IEEE Standard for Exchanging Information Between Networks Implementing IEC 61850 and IEEE Std 1815(TM) [Distributed Network Protocol (DNP3)]*. [Online]. Available: <https://standards.ieee.org/ieee/1815.1/5699/> (accessed: May 30 2023).
- [59] J. Mater, S. Kang, and R. Simpson, “White Paper: IEC 61850 and IEEE 2030.5: A Comparison of 2 Key Standards for DER Integration: An Update,” 2019. [Online]. Available: <https://cdn2.hubspot.net/hubfs/4533567/IEEE-2030-5-and-IEC-61850-comparison-082319.pdf>
- [60] *IEEE Standard for Interconnection and Interoperability of Distributed Energy Resources with Associated Electric Power Systems Interfaces*, Piscataway, NJ, USA.
- [61] J. Johnson, B. Fox, K. Kaur, and J. Anandan, “Evaluation of Interoperable Distributed Energy Resources to IEEE 1547.1 Using SunSpec Modbus, IEEE 1815, and IEEE 2030.5,” *IEEE Access*, vol. 9, pp. 142129–142146, 2021, doi: 10.1109/ACCESS.2021.3120304.
- [62] SerendiPV, “D6.1 Summary of technical constraints and recommendations for PV integration: T6.1 Technical constraints for high contribution,” 2022. [Online]. Available: <https://serendipv.eu/outputs/project-deliverables/download/d6-1-summary-of-technical-constraints-and-recommen>
- [63] P. C. David Joss, “PV-Wechselrichter stabilisieren das Netz: Alternative zu Netzausbau bei hoher PV-Einspeisung,” *bulletin.ch*, vol. 2023, 2023. [Online]. Available: <https://www.bulletin.ch/de/news-detail/pv-wechselrichter-stabilisieren-das-netz.html>



ISBN 978-3-907281-46-8



9 783907 281468